



OWNER'S MANUAL

FJR

FJR1300N

5JW-28199-20

Congratulations on your purchase of the Yamaha FJR1300. This model is the result of Yamaha's vast experience in the production of fine sporting, touring, and pacesetting racing machines. It represents the high degree of craftsmanship and reliability that have made Yamaha a leader in these fields.

This manual will give you an understanding of the operation, inspection, and basic maintenance of this motorcycle. If you have any questions concerning the operation or maintenance of your motorcycle, please consult a Yamaha dealer.

IMPORTANT MANUAL INFORMATION

Particularly important information is distinguished in this manual by the following notations:



The Safety Alert Symbol means **ATTENTION! BECOME ALERT! YOUR SAFETY IS INVOLVED!**



Failure to follow **WARNING** instructions could result in severe injury or death to the motorcycle operator, a bystander, or a person inspecting or repairing the motorcycle.

CAUTION:

A **CAUTION** indicates special precautions that must be taken to avoid damage to the motorcycle.

NOTE:

A **NOTE** provides key information to make procedures easier or clearer.

NOTE: _____

- This manual should be considered a permanent part of this motorcycle and should remain with it even if the motorcycle is subsequently sold.
 - Yamaha continually seeks advancements in product design and quality. Therefore, while this manual contains the most current product information available at the time of printing, there may be minor discrepancies between your motorcycle and this manual. If you have any questions concerning this manual, please consult your Yamaha dealer.
-

IMPORTANT MANUAL INFORMATION

EW000002

 **WARNING**

PLEASE READ THIS MANUAL CAREFULLY AND COMPLETELY BEFORE OPERATING THIS MOTORCYCLE.

IMPORTANT MANUAL INFORMATION

EAU03337

**FJR1300N
OWNER'S MANUAL
© 2001 by Yamaha Motor Co., Ltd.
1st Edition, March 2001
All rights reserved.
Any reprinting or unauthorized use
without the written permission of
Yamaha Motor Co., Ltd.
is expressly prohibited.
Printed in Japan.**

1 SAFETY INFORMATION	1
2 DESCRIPTION	2
3 INSTRUMENT AND CONTROL FUNCTIONS	3
4 PRE-OPERATION CHECKS	4
5 OPERATION AND IMPORTANT RIDING POINTS	5
6 PERIODIC MAINTENANCE AND MINOR REPAIR	6
7 MOTORCYCLE CARE AND STORAGE	7
8 SPECIFICATIONS	8
9 CONSUMER INFORMATION	9
INDEX	

Safe riding 1-1
Protective apparel 1-3
Modifications 1-3
Loading and accessories 1-3
Gasoline and exhaust gas..... 1-5
Location of important labels 1-7



MOTORCYCLES ARE SINGLE TRACK VEHICLES. THEIR SAFE USE AND OPERATION ARE DEPENDENT UPON THE USE OF PROPER RIDING TECHNIQUES AS WELL AS THE EXPERTISE OF THE OPERATOR. EVERY OPERATOR SHOULD KNOW THE FOLLOWING REQUIREMENTS BEFORE RIDING THIS MOTORCYCLE.

HE OR SHE SHOULD:

1. OBTAIN THOROUGH INSTRUCTIONS FROM A COMPETENT SOURCE ON ALL ASPECTS OF MOTORCYCLE OPERATION.
2. OBSERVE THE WARNINGS AND MAINTENANCE REQUIREMENTS IN THE OWNER'S MANUAL.
3. OBTAIN QUALIFIED TRAINING IN SAFE AND PROPER RIDING TECHNIQUES.
4. OBTAIN PROFESSIONAL TECHNICAL SERVICE AS INDICATED BY THE OWNER'S MANUAL AND/OR WHEN MADE NECESSARY BY MECHANICAL CONDITIONS.

Safe riding

1. Always make pre-operation checks. Careful checks may help prevent an accident.
2. This motorcycle is designed to carry the operator and a passenger.
3. The failure of motorists to detect and recognize motorcycles in traffic is the predominating cause of automobile/motorcycle accidents. Many accidents have been caused by an automobile driver who did not see the motorcycle. Making yourself conspicuous appears to be very effective in reducing the chance of this type of accident.

Therefore:

- a. Wear a brightly colored jacket.
- b. Use extra caution when you are approaching and passing through intersections, since intersections are the most likely places for motorcycle accidents to occur.
- c. Ride where other motorists can see you. Avoid riding in another motorist's blind spot.

4. Many accidents involve inexperienced operators. In fact, many operators who have been involved in accidents do not even have a current motorcycle license.
 - a. Make sure that you are qualified and that you only lend your motorcycle to other qualified operators.
 - b. Know your skills and limits. Staying within your limits may help you to avoid an accident.
 - c. We recommend that you practice riding your motorcycle where there is no traffic until you have become thoroughly familiar with the motorcycle and all of its controls.
5. Many accidents have been caused by error of the motorcycle operator. A typical error made by the operator is veering wide on a turn due to EXCESSIVE SPEED or undercornering (insufficient lean angle for the speed).
 - a. Always obey the speed limit and never travel faster than warranted by road and traffic conditions.
 - b. Always signal before turning or changing lanes. Make sure that other motorists can see you.
6. The posture of the operator and passenger is important for proper control.
 - a. The operator should keep both hands on the handlebar and both feet on the operator footrests during operation to maintain control of the motorcycle.
 - b. The passenger should always hold onto the operator, the seat strap or grab bar, if equipped, with both hands and keep both feet on the passenger footrests.
 - c. Never carry a passenger unless he or she can firmly place both feet on the passenger footrests.
7. Never ride under the influence of alcohol or other drugs.
8. This motorcycle is designed for on-road use only. It is not suitable for off-road use.

SAFETY INFORMATION

Protective apparel

The majority of fatalities from motorcycle accidents are the result of head injuries. The use of a safety helmet is the single most critical factor in the prevention or reduction of head injuries.

1. Always wear an approved helmet.
2. Wear a face shield or goggles. Wind in your unprotected eyes could contribute to an impairment of vision that could delay seeing a hazard.
3. The use of a jacket, heavy boots, trousers, gloves, etc., is effective in preventing or reducing abrasions or lacerations.
4. Never wear loose-fitting clothes, otherwise they could catch on the control levers, footrests, or wheels and cause injury or an accident.
5. Never touch the engine or exhaust system during or after operation. They become very hot and can cause burns. Always wear protective clothing that covers your legs, ankles, and feet.
6. A passenger should also observe the above precautions.

Modifications

Modifications made to this motorcycle not approved by Yamaha, or the removal of original equipment, may render the motorcycle unsafe for use and may cause severe personal injury. Modifications may also make your motorcycle illegal to use.

Loading and accessories

Adding accessories or cargo to your motorcycle can adversely affect stability and handling if the weight distribution of the motorcycle is changed. To avoid the possibility of an accident, use extreme caution when adding cargo or accessories to your motorcycle. Use extra care when riding a motorcycle that has added cargo or accessories. Here are some general guidelines to follow if loading cargo or adding accessories to your motorcycle:

Loading

The total weight of the operator, passenger, accessories and cargo must not exceed the maximum load limit of 208 kg. When loading within this weight limit, keep the following in mind:

1. Cargo and accessory weight should be kept as low and close to the motorcycle as possible. Make sure to distribute the weight as evenly as possible on both sides of the motorcycle to minimize imbalance or instability.
2. Shifting weights can create a sudden imbalance. Make sure that accessories and cargo are securely attached to the motorcycle before riding. Check accessory mounts and cargo restraints frequently.
3. Never attach any large or heavy items to the handlebar, front fork, or front fender. These items, including such items as sleeping bags, duffel bags, or tents, can create unstable handling or a slow steering response.

Accessories

Genuine Yamaha accessories have been specifically designed for use on this motorcycle. Since Yamaha cannot test all other accessories that may be available, you must personally be responsible for the proper selection, installation and use of non-Yamaha accessories. Use extreme caution when selecting and installing any accessories.

Keep the following guidelines in mind, as well as those provided under “Loading” when mounting accessories.

1. Never install accessories or carry cargo that would impair the performance of your motorcycle. Carefully inspect the accessory before using it to make sure that it does not in any way reduce ground clearance or cornering clearance, limit suspension travel, steering travel or control operation, or obscure lights or reflectors.

SAFETY INFORMATION

- a. Accessories fitted to the handlebar or the front fork area can create instability due to improper weight distribution or aerodynamic changes. If accessories are added to the handlebar or front fork area, they must be as lightweight as possible and should be kept to a minimum.
 - b. Bulky or large accessories may seriously affect the stability of the motorcycle due to aerodynamic effects. Wind may attempt to lift the motorcycle, or the motorcycle may become unstable in cross winds. These accessories may also cause instability when passing or being passed by large vehicles.
 - c. Certain accessories can displace the operator from his or her normal riding position. This improper position limits the freedom of movement of the operator and may limit control ability, therefore, such accessories are not recommended.
2. Use caution when adding electrical accessories. If electrical accessories exceed the capacity of the motorcycle's electrical system, an electric failure could result, which could cause a dangerous loss of lights or engine power.

Gasoline and exhaust gas

1. GASOLINE IS HIGHLY FLAMMABLE:
 - a. Always turn the engine off when refueling.
 - b. Take care not to spill any gasoline on the engine or exhaust system when refueling.
 - c. Never refuel while smoking or in the vicinity of an open flame.
2. Never start the engine or let it run for any length of time in a closed area. The exhaust fumes are poisonous and may cause loss of consciousness and death within a short time. Always operate your motorcycle in an area that has adequate ventilation.

SAFETY INFORMATION

3. Always turn the engine off before leaving the motorcycle unattended and remove the key from the main switch. When parking the motorcycle, note the following:
 - a. The engine and exhaust system may be hot, therefore, park the motorcycle in a place where pedestrians or children are not likely to touch these hot areas.
 - b. Do not park the motorcycle on a slope or soft ground, otherwise it may fall over.
 - c. Do not park the motorcycle near a flammable source (e.g., a kerosene heater, or near an open flame), otherwise it could catch fire.
4. When transporting the motorcycle in another vehicle, make sure that it is kept upright. If the motorcycle should lean over, gasoline may leak out of the fuel tank.
5. If you should swallow any gasoline, inhale a lot of gasoline vapor, or allow gasoline to get into your eyes, see your doctor immediately. If any gasoline spills on your skin or clothing, immediately wash the affected area with soap and water and change your clothes.

SAFETY INFORMATION

EAU02977

Location of important labels

Please read the following important labels carefully before operating this motorcycle.

1

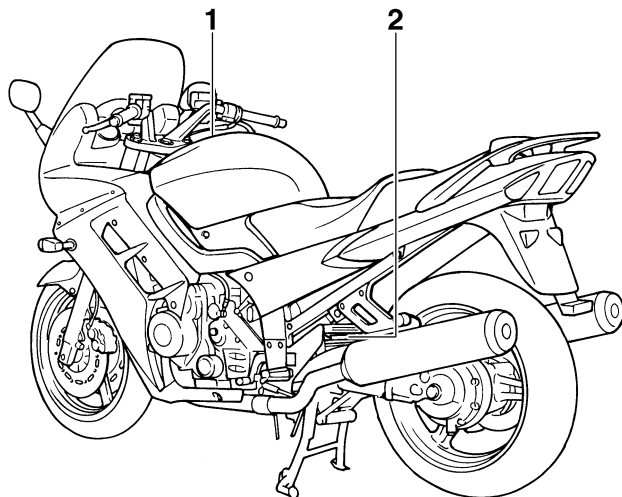

1

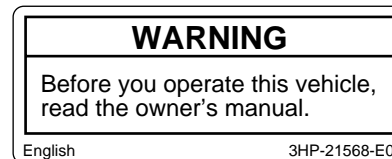

2



Left view	2-1
Right view.....	2-2
Controls and instruments	2-3

Left view

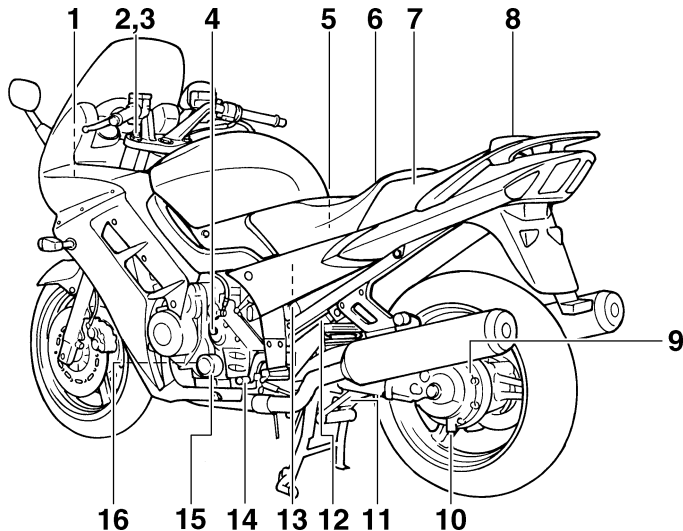

- | | | | |
|----------------------------------------------------|-------------|------------------------------------------------------------------|-------------|
| 1. Fuse box | (page 6-30) | 10. Final gear oil drain bolt | (page 6-12) |
| 2. Front fork spring preload adjusting bolt | (page 3-11) | 11. Shock absorber assembly rebound damping force adjusting knob | (page 3-14) |
| 3. Front fork rebound damping force adjusting knob | (page 3-12) | 12. Shock absorber assembly spring preload adjusting lever | (page 3-13) |
| 4. Engine oil filler cap | (page 6-10) | 13. Air filter element | (page 6-15) |
| 5. Owner's tool kit | (page 6-1) | 14. Shift pedal | (page 3-6) |
| 6. Rider seat | (page 3-10) | 15. Engine oil filter cartridge | (page 6-10) |
| 7. Passenger seat | (page 3-10) | 16. Engine oil level check window | (page 6-10) |
| 8. Rear carrier | | | |
| 9. Final gear oil filler bolt | (page 6-12) | | |

Right view

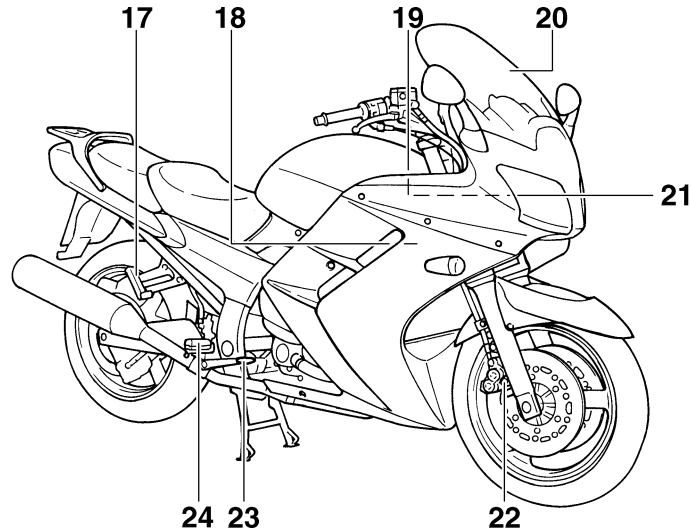

- 17. Passenger footrest
- 18. Coolant reservoir (page 6-13)
- 19. Battery (page 6-29)
- 20. Windshield
- 21. Main fuse and fuel injection system fuse (page 6-30)
- 22. Front fork compression damping force
adjusting screw (page 3-12)
- 23. Brake pedal (page 3-7)
- 24. Rider footrest

DESCRIPTION

Controls and instruments

2

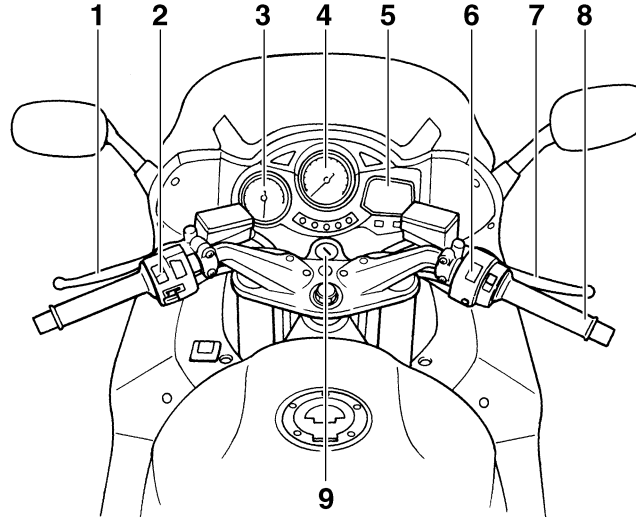

- | | |
|------------------------------|-------------|
| 1. Clutch lever | (page 3-6) |
| 2. Left handlebar switches | (page 3-5) |
| 3. Tachometer | (page 3-3) |
| 4. Speedometer | (page 3-3) |
| 5. Multi-function display | (page 3-3) |
| 6. Right handlebar switches | (page 3-5) |
| 7. Brake lever | (page 3-7) |
| 8. Throttle grip | (page 6-17) |
| 9. Main switch/steering lock | (page 3-1) |

INSTRUMENT AND CONTROL FUNCTIONS

Main switch/steering lock	3-1
Indicator and warning lights	3-2
Speedometer	3-3
Tachometer	3-3
Multi-function display	3-3
Handlebar switches	3-5
Clutch lever	3-6
Shift pedal	3-6
Brake lever	3-7
Brake pedal	3-7
Fuel tank cap	3-8
Fuel	3-9
Catalytic converter	3-9
Seats	3-10
Storage compartment	3-11
Adjusting the front fork	3-11
Adjusting the shock absorber assembly	3-13
Matching the front and rear suspension settings	3-15
Locks for the optional side cases and travel trunk	3-16
Sidestand	3-16
Ignition circuit cut-off system	3-17

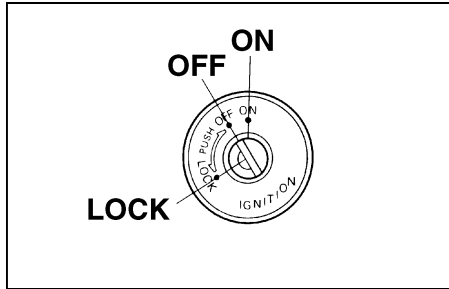

EAU00029

Main switch/steering lock

The main switch/steering lock controls the ignition and lighting systems, and is used to lock the steering. The various positions are described below.

ON

EAU00030

All electrical systems are supplied with power, and the headlight, meter lighting and taillight come on, and the engine can be started. The key cannot be removed.

OFF

EAU00038

All electrical systems are off. The key can be removed.

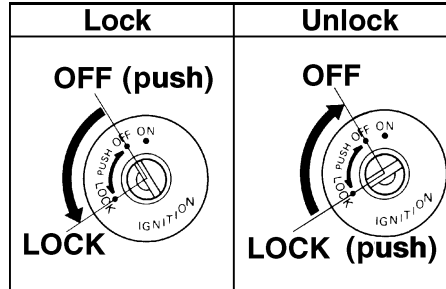

EAU00040

LOCK

The steering is locked, and all electrical systems are off. The key can be removed.

To lock the steering

1. Turn the handlebars all the way to the left.
2. Push the key in from the "OFF" position, and then turn it to "LOCK" while still pushing it.
3. Remove the key.

To unlock the steering

Push the key in, and then turn it to "OFF" while still pushing it.

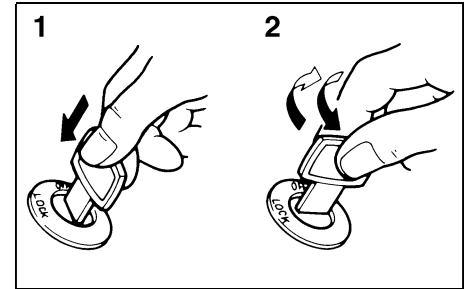

1. Push.
2. Turn.





EW000016

! WARNING

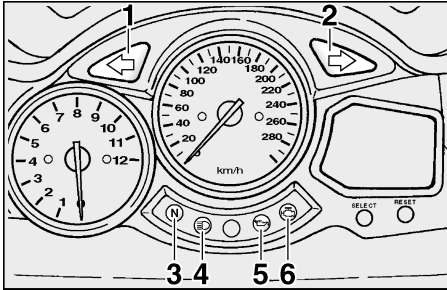
Never turn the key to "OFF" or "LOCK" while the motorcycle is moving, otherwise the electrical systems will be switched off, which may result in loss of control or an accident. Make sure that the motorcycle is stopped before turning the key to "OFF" or "LOCK".

INSTRUMENT AND CONTROL FUNCTIONS



1. Left turn signal indicator light “”
2. Right turn signal indicator light “”
3. Neutral indicator light “**N**”
4. High beam indicator light “”
5. Oil level warning light “”
6. Engine trouble warning light “”

Indicator and warning lights

EAU03034

Turn signal indicator lights

“” and “”

EAU04121

The corresponding indicator light flashes when the turn signal switch is pushed to the left or right.

Neutral indicator light “**N**”

EAU00061

This indicator light comes on when the transmission is in the neutral position.

High beam indicator light “”

EAU00063

This indicator light comes on when the high beam of the headlight is switched on.

Oil level warning light “”

EAU03201

This warning light comes on when the engine oil level is low.

The electrical circuit of the warning light can be checked according to the following procedure.

1. Set the engine stop switch to “” and turn the key to “ON”.
2. Shift the transmission into the neutral position or pull the clutch lever.
3. Push the start switch. If the warning light does not come on while pushing the start switch, have a Yamaha dealer check the electrical circuit.

NOTE: _____

Even if the oil level is sufficient, the warning light may flicker when riding on a slope or during sudden acceleration or deceleration, but this is not a malfunction.

Engine trouble warning light “”

EAU03192

This warning light comes on or flashes when an electrical circuit monitoring the engine is defective. When this occurs, have the Yamaha dealer check the self-diagnosis system.

The electrical circuit of the warning light can be checked according to the following procedure.

1. Set the engine stop switch to “”.
2. Turn the key to “ON”. If the warning light does not come on, have a Yamaha dealer check the electrical circuit.

INSTRUMENT AND CONTROL FUNCTIONS

3

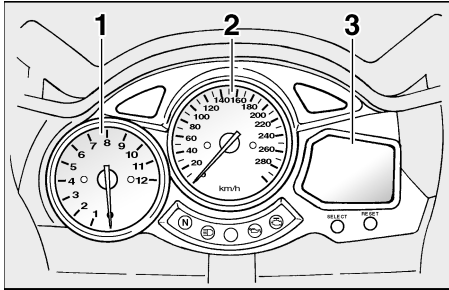

1. Tachometer
2. Speedometer
3. Multi-function display

EAU04031

Speedometer

The speedometer shows the riding speed.

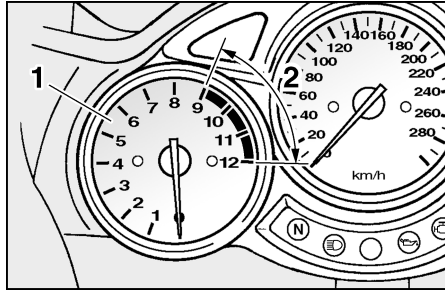

1. Tachometer
2. Tachometer red zone

EAU00101

Tachometer

The electric tachometer allows the rider to monitor the engine speed and keep it within the ideal power range.

EC000003

CAUTION:

Do not operate the engine in the tachometer red zone.

Red zone: 9,000 r/min and above

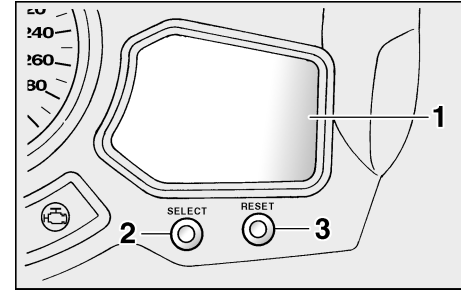

1. Multi-function display
2. "SELECT" button
3. "RESET" button

EAU04095

Multi-function display

The multi-function display is equipped with the following:

- a fuel gauge
- a coolant temperature gauge
- an odometer (which shows the total distance traveled)
- two tripmeters (which show the distance traveled since they were last set to zero)
- a fuel reserve tripmeter (which shows the distance traveled on the fuel reserve)

- a selfdiagnosis device
- a clock

Odometer and tripmeter modes

Pushing the “SELECT” button switches the display between the odometer mode “ODO” and the tripmeter modes “TRIP” in the following order:

ODO → TRIP (top) → TRIP (bottom)
→ODO

When approximately 5 L of fuel remains in the fuel tank, the display will automatically change to the fuel reserve tripmeter mode “TRIP F” and start counting the distance traveled from that point. In that case, pushing the “SELECT” button switches the display between the various tripmeter and odometer modes in the following order:
TRIP F → TRIP (top) → TRIP (bottom)
→ ODO → TRIP F

To reset a tripmeter, select it by pushing the “SELECT” button, and then push the “RESET” button for at least one second. If you do not reset the fuel reserve tripmeter manually, it will reset itself automatically and the display will return to the prior mode after refueling and traveling 5 km.

Self-diagnosis device

This model is equipped with a self-diagnosis device for various electrical circuits.

If any of those circuits are defective, the clock will indicate a two-digit error code (e.g., 11, 12, 13).

If the clock indicates such an error code, note the code number, and then have a Yamaha dealer check the motorcycle.

CAUTION:

If the clock indicates an error code, the motorcycle should be checked as soon as possible in order to avoid engine damage.

Clock mode

To set the clock:

1. Push the “SELECT” button and “RESET” button together for at least two seconds.
2. When the hour digits start flashing, push the “RESET” button to set the hours.
3. Push the “SELECT” button, and the minute digits will start flashing.
4. Push the “RESET” button to set the minutes.
5. Push the “SELECT” button and then release it to start the clock.

INSTRUMENT AND CONTROL FUNCTIONS

3

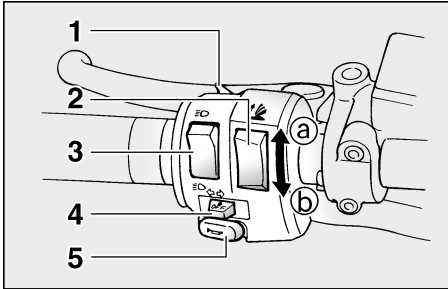

1. Pass switch “≡〇”
2. Windshield position adjusting switch “↕”
3. Dimmer switch “≡〇 / ≡〇”
4. Turn signal switch “↵ / ⇨”
5. Horn switch “📢”

Handlebar switches

EAU00118

Pass switch “≡〇”

Press this switch to flash the headlight.

EAU00119

Dimmer switch “≡〇 / ≡〇”

Set this switch to “≡〇” for the high beam and to “≡〇” for the low beam.

EAU03888

Windshield position adjusting switch “↕”

EAU04077

To move the windshield up, push this switch in direction (a). To move the windshield down, push the switch in direction (b).

NOTE:

When the engine is turned off, the windshield will automatically return to the lowest position.

EAU03889

Turn signal switch “↵ / ⇨”

To signal a right-hand turn, push this switch to “⇨”. To signal a left-hand turn, push this switch to “↵”. When released, the switch returns to the center position. To cancel the turn signal lights, push the switch in after it has returned to the center position.

EAU00129

Horn switch “📢”

Press this switch to sound the horn.

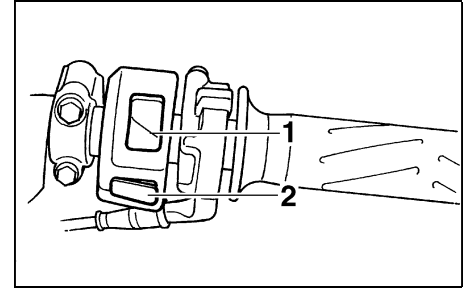

1. Engine stop switch “○ / ✕”
2. Start switch “⚡”

EAU03890

Engine stop switch “○ / ✕”

Set this switch to “○” before starting the engine. Set this switch to “✕” to stop the engine in case of an emergency, such as when the motorcycle overturns or when the throttle cable is stuck.

EAU00143

Start switch “⚡”

Push this switch to crank the engine with the starter.

EC000005

CAUTION:

See page 5-1 for starting instructions prior to starting the engine.

Clutch lever

EAU00153

The clutch lever is located at the left handlebar grip. To disengage the clutch, pull the lever toward the handlebar grip. To engage the clutch, release the lever. The lever should be pulled rapidly and released slowly for smooth clutch operation.

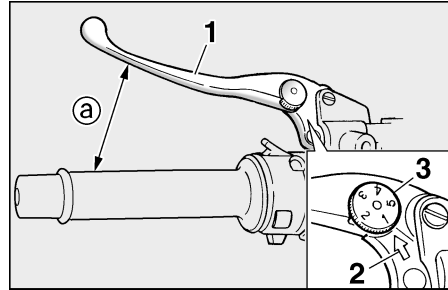

1. Clutch lever
 2. Arrow mark
 3. Clutch lever position adjusting dial
- a. Distance between clutch lever and handlebar grip

The clutch lever is equipped with a clutch lever position adjusting dial. To adjust the distance between the clutch lever and the handlebar grip, turn the adjusting dial while holding the lever pushed away from the handlebar grip. Make sure that the appropriate setting on the adjusting dial is aligned with the arrow mark on the clutch lever.

The clutch lever is equipped with a clutch switch, which is part of the ignition circuit cut-off system. (See page 3-17 for an explanation of the ignition circuit cut-off system.)

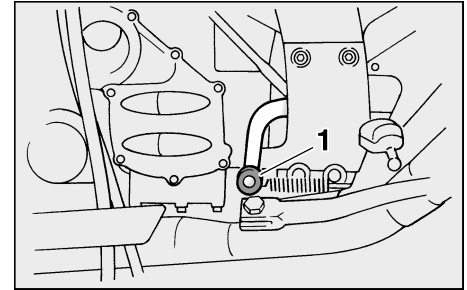

1. Shift pedal

EAU00157

Shift pedal

The shift pedal is located on the left side of the engine and is used in combination with the clutch lever when shifting the gears of the 5-speed constant-mesh transmission equipped on this motorcycle.

INSTRUMENT AND CONTROL FUNCTIONS

Brake lever

The brake lever is located at the right handlebar grip. To apply the front brake, pull the lever toward the handlebar grip.

EAU00161

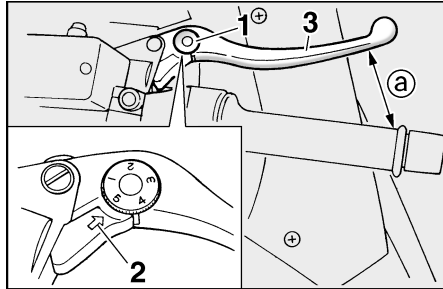

1. Brake lever position adjusting dial
2. Arrow mark
3. Brake lever
- a. Distance between brake lever and handlebar grip

The brake lever is equipped with a position adjusting dial. To adjust the distance between the brake lever and the handlebar grip, turn the adjusting dial while holding the lever pushed away from the handlebar grip. Make sure that the appropriate setting on the adjusting dial is aligned with the arrow mark on the brake lever.

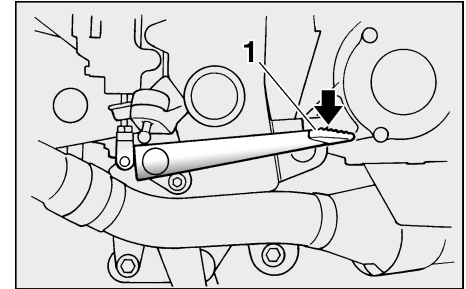

1. Brake pedal

EAU00162

Brake pedal

The brake pedal is on the right side of the motorcycle. To apply the rear brake, press down on the brake pedal.

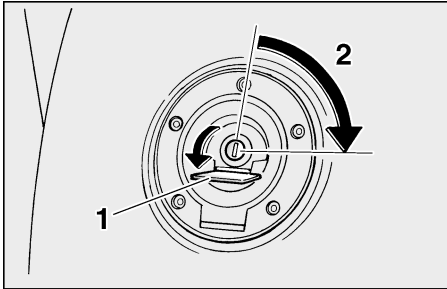

1. Fuel tank cap lock cover
2. Unlock.

EAU04068

Fuel tank cap

To open the fuel tank cap

Open the fuel tank cap lock cover, insert the key into the lock, and then turn it 1/4 turn clockwise. The lock will be released and the fuel tank cap can be opened.

To close the fuel tank cap

1. Push the fuel tank cap into position with the key inserted in the lock.
2. Remove the key, and then close the lock cover.

NOTE: _____
The fuel tank cap cannot be closed unless the key is in the lock. In addition, the key cannot be removed if the cap is not properly closed and locked.

EWA00025

WARNING

Make sure that the fuel tank cap is properly closed before riding.

INSTRUMENT AND CONTROL FUNCTIONS

3

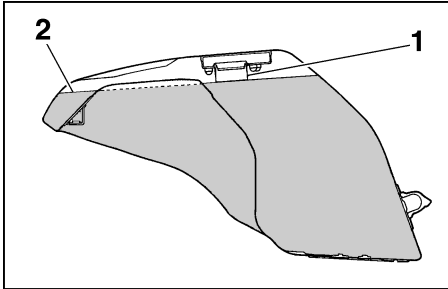

1. Fuel tank filler tube
2. Fuel level

EAU03753

Fuel

Make sure that there is sufficient fuel in the tank. Fill the fuel tank to the bottom of the filler tube as shown.

EW000130

! WARNING

- Do not overfill the fuel tank, otherwise it may overflow when the fuel warms up and expands.
- Avoid spilling fuel on the hot engine.

EAU00185

CAUTION:

Immediately wipe off spilled fuel with a clean, dry, soft cloth, since fuel may deteriorate painted surfaces or plastic parts.

EAU00192*

Recommended fuel:
Unleaded fuel only
Fuel tank capacity:
Total amount:
25 L
Reserve amount:
5 L

EAU01084

Catalytic converter

This motorcycle is equipped with a catalytic converter in the exhaust chamber.

EW000128

! WARNING

The exhaust system is hot after operation. Make sure that the exhaust system has cooled down before doing any maintenance work.

EC000114

CAUTION:

The following precautions must be observed to prevent a fire hazard or other damages.

- Use only unleaded gasoline. The use of leaded gasoline will cause unreparable damage to the catalytic converter.
- Never park the motorcycle near possible fire hazards such as grass or other materials that easily burn.
- Do not allow the engine to idle too long.

INSTRUMENT AND CONTROL FUNCTIONS

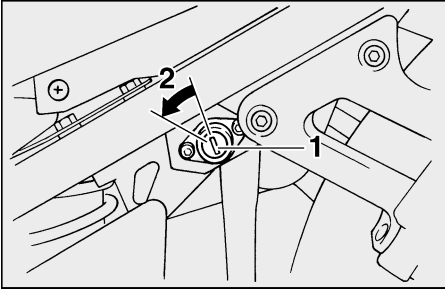

1. Rider seat lock
2. Unlock.

EAU03945

Seats

Rider seat

To remove the rider seat

1. Insert the key into the seat lock, and then turn it as shown.
2. Pull the rider seat off.

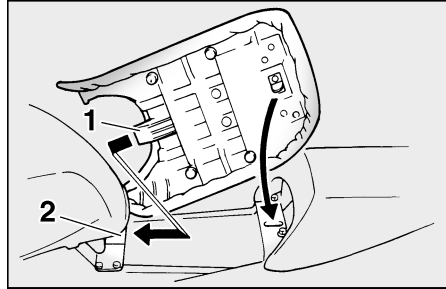

1. Projection
2. Seat holder

To install the rider seat

1. Insert the projection on the front of the rider seat into the seat holder as shown, and then push the rear of the seat down to lock it in place.
2. Remove the key.

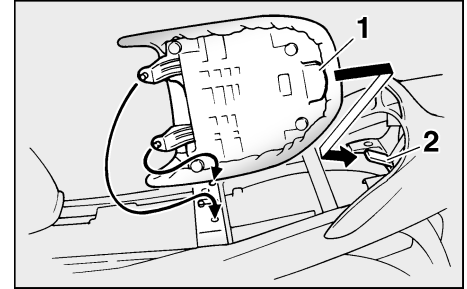

1. Receptacle
2. Seat holder

Passenger seat

To remove the passenger seat

1. Remove the rider seat.
2. Pull the passenger seat up.

To install the passenger seat

1. Slide the receptacle on the rear of the passenger seat over the seat holder as shown, and then push the front of the seat down.
2. Install the rider seat.

NOTE: _____
Make sure that the seats are properly secured before riding.

INSTRUMENT AND CONTROL FUNCTIONS

3

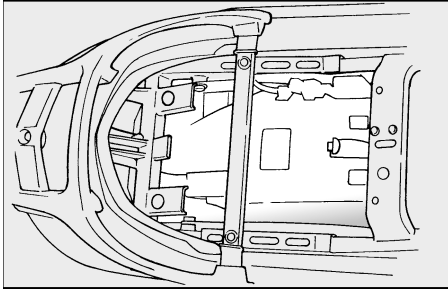

EAU01242

Storage compartment

The storage compartment is located under the passenger seat. (See page 3-10 for passenger seat opening and closing procedures.)

EWA00005

WARNING

- Do not exceed the load limit of 3 kg for the storage compartment.
- Do not exceed the maximum load of 208 kg for the vehicle.

EAU03949*

Adjusting the front fork

This front fork is equipped with spring preload adjusting bolts, rebound damping force adjusting knobs and compression damping force adjusting screws.

EW000035

WARNING

Always adjust both fork legs equally, otherwise poor handling and loss of stability may result.

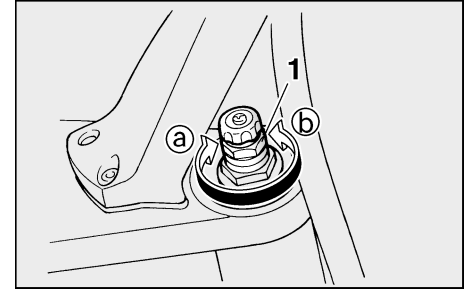

1. Rebound damping force adjusting knob
2. Spring preload adjusting bolt

Spring preload

To increase the spring preload and thereby harden the suspension, turn the adjusting bolt on each fork leg in direction **(a)**. To decrease the spring preload and thereby soften the suspension, turn the adjusting bolt on each fork leg in direction **(b)**.

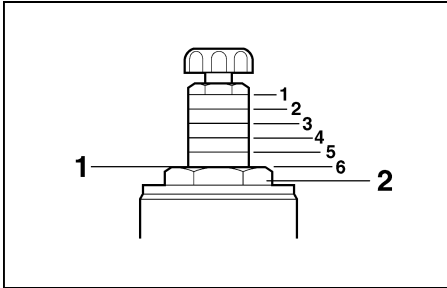

1. Current setting
2. Front fork cap bolt

NOTE: _____
Align the appropriate groove on the adjusting mechanism with the top of the front fork cap bolt.

Setting	Hard		Stan- dard	Soft		
	1	2	3	4	5	6

Rebound damping force

To increase the rebound damping force and thereby harden the rebound damping, turn the adjusting knob on each fork leg in direction Ⓐ. To decrease the rebound damping force and thereby soften the rebound damping, turn the adjusting knob on each fork leg in direction Ⓑ.

Minimum (soft)	17 clicks in direction Ⓐ*
Standard	12 clicks in direction Ⓐ*
Maximum (hard)	1 click in direction Ⓐ*

* With the adjusting knob fully turned in direction Ⓐ

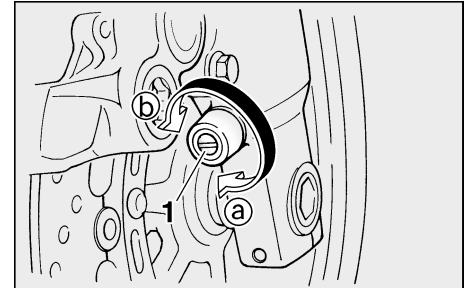

1. Compression damping force adjusting screw

Compression damping force

To increase the compression damping force and thereby harden the compression damping, turn the adjusting screw on each fork leg in direction Ⓐ. To decrease the compression damping force and thereby soften the compression damping, turn the adjusting screw on each fork leg in direction Ⓑ.

Minimum (soft)	21 clicks in direction Ⓐ*
Standard	12 clicks in direction Ⓐ*
Maximum (hard)	1 click in direction Ⓐ*

* With the adjusting screw fully turned in direction Ⓐ

INSTRUMENT AND CONTROL FUNCTIONS

EC000015

CAUTION:

Never attempt to turn an adjusting mechanism beyond the maximum or minimum settings.

NOTE:

Although the total number of clicks of a damping force adjusting mechanism may not exactly match the above specifications due to small differences in production, the actual number of clicks always represents the entire adjusting range. To obtain a precise adjustment, it would be advisable to check the number of clicks of each damping force adjusting mechanism and to modify the specifications as necessary.

EAU03950

Adjusting the shock absorber assembly

This shock absorber assembly is equipped with a spring preload adjusting lever and a rebound damping force adjusting knob.

EC000015

CAUTION:

Never attempt to turn an adjusting mechanism beyond the maximum or minimum settings.

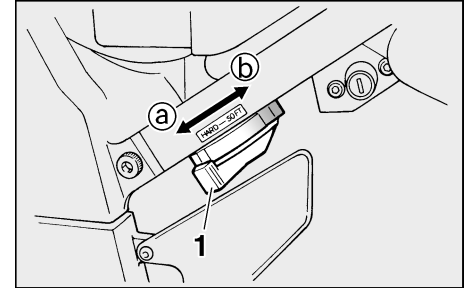

1. Spring preload adjusting lever
- a. "HARD"
- b. "SOFT"

Spring preload

For riding solo, move the spring preload adjusting lever to "SOFT". For riding with a passenger, move the spring preload adjusting lever to "HARD".

EAU00315

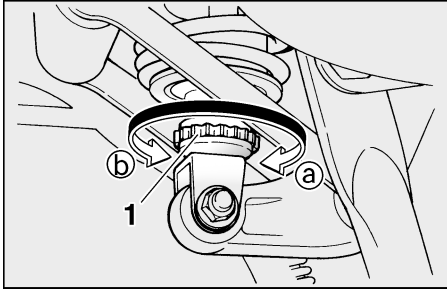

1. Rebound damping force adjusting knob

Rebound damping force

To increase the rebound damping force and thereby harden the rebound damping, turn the adjusting knob in direction ①. To decrease the rebound damping force and thereby soften the rebound damping, turn the adjusting knob in direction ②.

Minimum (soft)	20 clicks in direction ②*
Standard	10 clicks in direction ②*
Maximum (hard)	3 clicks in direction ①*

* With the adjusting knob fully turned in direction ③

⚠ WARNING

This shock absorber contains highly pressurized nitrogen gas. For proper handling, read and understand the following information before handling the shock absorber. The manufacturer cannot be held responsible for property damage or personal injury that may result from improper handling.

- Do not tamper with or attempt to open the gas cylinder.
- Do not subject the shock absorber to an open flame or other high heat sources, otherwise it may explode due to excessive gas pressure.
- Do not deform or damage the gas cylinder in any way, as this will result in poor damping performance.
- Always have a Yamaha dealer service the shock absorber.

INSTRUMENT AND CONTROL FUNCTIONS

EAU04075

Matching the front and rear suspension settings

Use this table as a guide to match the suspension and damping adjustments of the front fork and shock absorber assembly according to various load conditions.

Load condition	Front fork adjustment			Shock absorber assembly adjustment	
	Spring preload	Compression damping force	Rebound damping force	Spring preload	Rebound damping force
Rider only	3	12	12	SOFT	10
With passenger or cargo	3	12	8-10	HARD	6-8

EC000015

CAUTION:

Never attempt to turn an adjusting mechanism beyond the maximum or minimum settings.

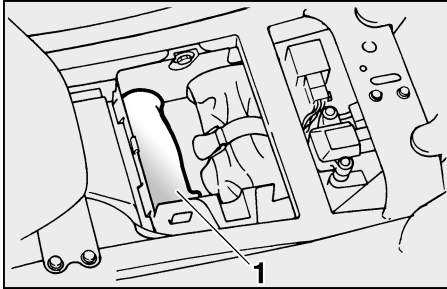

1. Plastic bag containing locks

EAU04043

Locks for the optional side cases and travel trunk

There are three locks in a plastic bag located beside the owner's tool kit. When used to replace the locks of the optional side cases and travel trunk, which can be obtained at a Yamaha dealer, these locks can be operated with the ignition key. Keep these locks in a safe place to prevent losing them.

Sidestand

The sidestand is located on the left side of the frame. Raise the sidestand or lower it with your foot while holding the motorcycle upright.

NOTE:

The built-in sidestand switch is part of the ignition circuit cut-off system, which cuts the ignition in certain situations. (See further down for an explanation of the ignition circuit cut-off system.)

! WARNING

The motorcycle must not be ridden with the sidestand down, or if the sidestand cannot be properly moved up (or does not stay up), otherwise the sidestand could contact the ground and distract the operator, resulting in a possible loss of control. Yamaha's ignition circuit cut-off system has been designed to assist the operator in fulfilling the responsibility of raising the sidestand before starting off. Therefore, check this system regularly as described below and have a Yamaha dealer repair it if it does not function properly.

INSTRUMENT AND CONTROL FUNCTIONS

EAU03741

EW000046

Ignition circuit cut-off system

The ignition circuit cut-off system (comprising the sidestand switch, clutch switch and neutral switch) has the following functions.

- It prevents starting when the transmission is in gear and the sidestand is up, but the clutch lever is not pulled.
- It prevents starting when the transmission is in gear and the clutch lever is pulled, but the sidestand is still down.
- It cuts the running engine when the transmission is in gear and the sidestand is moved down.

Periodically check the operation of the ignition circuit cut-off system according to the following procedure.

WARNING

- **The vehicle must be placed on the centerstand during this inspection.**
 - **If a malfunction is noted, have a Yamaha dealer check the system before riding.**
-

INSTRUMENT AND CONTROL FUNCTIONS

With the engine turned off:
1. Move the sidestand down.
2. Make sure that the engine stop switch is set to “○”.
3. Turn the key to “ON”.
4. Shift the transmission into the neutral position.
5. Push the start switch.
Does the engine start?

YES NO

NOTE: _____
This check is most reliable if performed with a warmed-up engine.

The neutral switch may be defective.
The motorcycle should not be ridden until checked by a Yamaha dealer.

With the engine still running:
6. Move the sidestand up.
7. Keep the clutch lever pulled.
8. Shift the transmission into gear.
9. Move the sidestand down.
Does the engine stall?

YES NO

The sidestand switch may be defective.
The motorcycle should not be ridden until checked by a Yamaha dealer.

After the engine has stalled:
10. Move the sidestand up.
11. Keep the clutch lever pulled.
12. Push the start switch.
Does the engine start?

YES NO

The clutch switch may be defective.
The motorcycle should not be ridden until checked by a Yamaha dealer.

The system is OK. **The motorcycle can be ridden.**

Pre-operation check list 4-1

PRE-OPERATION CHECKS

The condition of a vehicle is the owner's responsibility. Vital components can start to deteriorate quickly and unexpectedly, even if the vehicle remains unused (for example, as a result of exposure to the elements). Any damage, fluid leakage or loss of tire air pressure could have serious consequences. Therefore, it is very important, in addition to a thorough visual inspection, to check the following points before each ride.

Pre-operation check list

ITEM	CHECKS	PAGE
Fuel	<ul style="list-style-type: none">• Check fuel level in fuel tank.• Refuel if necessary.• Check fuel line for leakage.	3-9
Engine oil	<ul style="list-style-type: none">• Check oil level in engine.• If necessary, add recommended oil to specified level.• Check vehicle for oil leakage.	6-9-6-11
Final gear oil	<ul style="list-style-type: none">• Check vehicle for oil leakage.	6-12
Coolant	<ul style="list-style-type: none">• Check coolant level in reservoir.• If necessary, add recommended coolant to specified level.• Check cooling system for leakage.	6-13-6-14
Front brake	<ul style="list-style-type: none">• Check operation.• If soft or spongy, have Yamaha dealer bleed hydraulic system.• Check fluid level in reservoir.• If necessary, add recommended brake fluid to specified level.• Check hydraulic system for leakage.	6-21, 6-23-6-25
Rear brake	<ul style="list-style-type: none">• Check operation.• If soft or spongy, have Yamaha dealer bleed hydraulic system.• Check fluid level in reservoir.• If necessary, add recommended brake fluid to specified level.• Check hydraulic system for leakage.	6-21-6-25

4

PRE-OPERATION CHECKS

ITEM	CHECKS	PAGE
Clutch	<ul style="list-style-type: none"> • Check operation. • If soft or spongy, have Yamaha dealer bleed hydraulic system. • Check fluid level in reservoir. • If necessary, add recommended brake fluid to specified level. • Check hydraulic system for leakage. 	6-20, 6-25
Throttle grip	<ul style="list-style-type: none"> • Make sure that operation is smooth. • Lubricate throttle grip, housing and cables if necessary. • Check free play. • If necessary, have Yamaha dealer make adjustment. 	6-17, 6-25
Wheels and tires	<ul style="list-style-type: none"> • Check for damage. • Check tire condition and tread depth. • Check air pressure. • Correct if necessary. 	6-17-6-20
Brake and shift pedals	<ul style="list-style-type: none"> • Make sure that operation is smooth. • Lubricate pedal pivoting points if necessary. 	6-25
Brake and clutch levers	<ul style="list-style-type: none"> • Make sure that operation is smooth. • Lubricate lever pivoting points if necessary. 	6-25
Centerstand, sidestand	<ul style="list-style-type: none"> • Make sure that operation is smooth. • Lubricate pivots if necessary. 	6-26
Chassis fasteners	<ul style="list-style-type: none"> • Make sure that all nuts, bolts and screws are properly tightened. • Tighten if necessary. 	—
Instruments, lights, signals and switches	<ul style="list-style-type: none"> • Check operation. • Correct if necessary. 	—
Sidestand switch	<ul style="list-style-type: none"> • Check operation of ignition circuit cut-off system. • If system is defective, have Yamaha dealer check vehicle. 	3-16

PRE-OPERATION CHECKS

NOTE:

Pre-operation checks should be made each time the motorcycle is used. Such an inspection can be accomplished in a very short time; and the added safety it assures is more than worth the time involved.

EWA00033

 WARNING

If any item in the Pre-operation check list is not working properly, have it inspected and repaired before operating the motorcycle.

OPERATION AND IMPORTANT RIDING POINTS

Starting and warming up a cold engine	5-1
Shifting	5-2
Tips for reducing fuel consumption	5-3
Engine break-in	5-3
Parking	5-4

EAU00373

⚠ WARNING

- Become thoroughly familiar with all operating controls and their functions before riding. Consult a Yamaha dealer regarding any control or function that you do not thoroughly understand.
- Never start the engine or operate it in a closed area for any length of time. Exhaust fumes are poisonous, and inhaling them can cause loss of consciousness and death within a short time. Always make sure that there is adequate ventilation.
- Before starting out, make sure that the sidestand is up. If the sidestand is not raised completely, it could contact the ground and distract the operator, resulting in a possible loss of control.

Starting and warming up a cold engine

In order for the ignition circuit cut-off system to enable starting, one of the following conditions must be met:

- The transmission is in the neutral position.
- The transmission is in gear with the clutch lever pulled and the sidestand up.

EAU04096

EW000054

⚠ WARNING

- Before starting the engine, check the function of the ignition circuit cut-off system according to the procedure described on page 3-18.
 - Never ride with the sidestand down.
1. Turn the key to "ON" and make sure that the engine stop switch is set to "○".

ECA00083

CAUTION:

The oil level warning light and engine trouble warning light should come on for a few seconds, then go off. If a warning light does not go off, see pages 3-2 and 3-3 for the corresponding warning light circuit check.

2. Shift the transmission into the neutral position.

NOTE:

When the transmission is in the neutral position, the neutral indicator light should be on, otherwise have a Yamaha dealer check the electrical circuit.

3. Start the engine by pushing the start switch.

OPERATION AND IMPORTANT RIDING POINTS

EC000048

NOTE:

If the engine fails to start, release the start switch, wait a few seconds, and then try again. Each starting attempt should be as short as possible to preserve the battery. Do not crank the engine more than 10 seconds on any one attempt.

ECA00045

CAUTION:

For maximum engine life, never accelerate hard when the engine is cold!

NOTE:

The engine is warm when it quickly responds to the throttle.

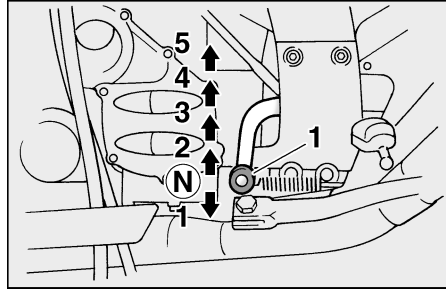

1. Shift pedal
- N. Neutral position

EAU00423

Shifting

Shifting gears lets you control the amount of engine power available for starting off, accelerating, climbing hills, etc.

The gear positions are shown in the illustration.

NOTE:

To shift the transmission into the neutral position, press the shift pedal down repeatedly until it reaches the end of its travel, and then slightly raise it.

CAUTION:

- Even with the transmission in the neutral position, do not coast for long periods of time with the engine off, and do not tow the motorcycle for long distances. The transmission is properly lubricated only when the engine is running. Inadequate lubrication may damage the transmission.
- Always use the clutch while changing gears to avoid damaging the engine, transmission, and drive train, which are not designed to withstand the shock of forced shifting.

OPERATION AND IMPORTANT RIDING POINTS

Tips for reducing fuel consumption

EAU03952

Fuel consumption depends largely on your riding style. Consider the following tips to reduce fuel consumption:

- Thoroughly warm up the engine.
- Shift up swiftly, and avoid high engine speeds during acceleration.
- Do not rev the engine while shifting down, and avoid high engine speeds with no load on the engine.
- Turn the engine off instead of letting it idle for an extended length of time (e.g., in traffic jams, at traffic lights or at railroad crossings).

Engine break-in

EAU01128

There is never a more important period in the life of your engine than the period between 0 and 1,600 km. For this reason, you should read the following material carefully.

Since the engine is brand new, do not put an excessive load on it for the first 1,600 km. The various parts in the engine wear and polish themselves to the correct operating clearances. During this period, prolonged full-throttle operation or any condition that might result in engine overheating must be avoided.

0–1,000 km

EAU04032*

Avoid prolonged operation above 5,000 r/min.

1,000–1,600 km

Avoid prolonged operation above 6,000 r/min.

EC000056*

CAUTION:

After 1,000 km of operation, the engine oil and final gear oil must be changed, and the oil filter cartridge replaced.

1,600 km and beyond

The vehicle can now be operated normally.

EC000053

CAUTION:

- Keep the engine speed out of the tachometer red zone.
 - If any engine trouble should occur during the engine break-in period, immediately have a Yamaha dealer check the vehicle.
-

EAU00461

Parking

When parking, stop the engine, and then remove the key from the main switch.

EW000058

WARNING

- Since the engine and exhaust system can become very hot, park in a place where pedestrians or children are not likely to touch them.
- Do not park on a slope or on soft ground, otherwise the motorcycle may overturn.

EC000062

CAUTION:

Never park in an area where there are fire hazards such as grass or other flammable materials.

PERIODIC MAINTENANCE AND MINOR REPAIR

Owner's tool kit	6-1	Checking and lubricating the cables	6-24
Periodic maintenance and lubrication chart	6-2	Checking and lubricating the throttle grip and cable	6-25
Removing and installing the cowling and panels	6-5	Checking and lubricating the brake and shift pedals	6-25
Checking the spark plugs	6-8	Checking and lubricating the brake and clutch levers	6-25
Engine oil and oil filter cartridge	6-9	Checking and lubricating the centerstand and sidestand	6-26
Final gear oil	6-12	Lubricating the rear suspension	6-26
Checking the coolant level	6-13	Checking the front fork	6-27
Cleaning the air filter element	6-15	Checking the steering	6-27
Checking the engine idling speed	6-16	Checking the wheel bearings	6-28
Adjusting the throttle cable free play	6-17	Battery	6-29
Adjusting the valve clearance	6-17	Replacing the fuses	6-30
Tires	6-17	Replacing a headlight bulb	6-31
Cast wheels	6-20	Replacing a tail/brake light bulb	6-32
Clutch lever free play	6-20	Replacing a turn signal light bulb	6-33
Adjusting the brake lever free play	6-21	Troubleshooting	6-33
Adjusting the brake pedal position	6-21	Troubleshooting charts	6-34
Adjusting the rear brake light switch	6-22		
Checking the front and rear brake pads	6-22		
Checking the brake and clutch fluid levels	6-23		
Changing the brake and clutch fluids	6-24		

EAU00464

Safety is an obligation of the owner. Periodic inspection, adjustment and lubrication will keep your vehicle in the safest and most efficient condition possible. The most important points of inspection, adjustment, and lubrication are explained on the following pages.

The intervals given in the periodic maintenance and lubrication chart should be simply considered as a general guide under normal riding conditions. However, **DEPENDING ON THE WEATHER, TERRAIN, GEOGRAPHICAL LOCATION, AND INDIVIDUAL USE, THE MAINTENANCE INTERVALS MAY NEED TO BE SHORTENED.**

EW000060

⚠ WARNING

If you are not familiar with motorcycle maintenance work, have a Yamaha dealer do it for you.

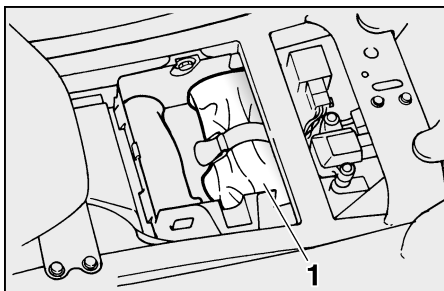

1. Owner's tool kit

EAU03711

Owner's tool kit

The owner's tool kit is located under the rider seat. (See page 3-10 for rider seat removal and installation procedures.)

The service information included in this manual and the tools provided in the owner's tool kit are intended to assist you in the performance of preventive maintenance and minor repairs. However, additional tools such as a torque wrench may be necessary to perform certain maintenance work correctly.

NOTE:

If you do not have the tools or experience required for a particular job, have a Yamaha dealer perform it for you.

EW000063

⚠ WARNING

Modifications not approved by Yamaha may cause loss of performance and render the vehicle unsafe for use. Consult a Yamaha dealer before attempting any changes.

PERIODIC MAINTENANCE AND MINOR REPAIR

EAU03685

Periodic maintenance and lubrication chart

NOTE:

- The annual checks must be performed every year, except if a kilometer-based maintenance is performed instead.
- From 50,000 km, repeat the maintenance intervals starting from 10,000 km.
- Items marked with an asterisk should be performed by a Yamaha dealer as they require special tools, data and technical skills.

NO.	ITEM	CHECK OR MAINTENANCE JOB	ODOMETER READING (× 1,000 km)					ANNUAL CHECK
			1	10	20	30	40	
1	* Fuel line	• Check fuel hoses for cracks or damage.		√	√	√	√	√
2	Spark plugs	• Check condition. • Clean and regap.		√		√		
		• Replace.			√		√	
3	* Valves	• Check valve clearance. • Adjust.	Every 40,000 km					
4	Air filter element	• Clean.		√		√		
		• Replace.			√		√	
5	* Clutch	• Check operation, fluid level and vehicle for fluid leakage. (See NOTE on page 6-4.)	√	√	√	√	√	
6	* Front brake	• Check operation, fluid level and vehicle for fluid leakage. (See NOTE on page 6-4.)	√	√	√	√	√	√
		• Replace brake pads.	Whenever worn to the limit					
7	* Rear brake	• Check operation, fluid level and vehicle for fluid leakage. (See NOTE on page 6-4.)	√	√	√	√	√	√
		• Replace brake pads.	Whenever worn to the limit					

PERIODIC MAINTENANCE AND MINOR REPAIR

NO.	ITEM	CHECK OR MAINTENANCE JOB	ODOMETER READING ($\times 1,000$ km)					ANNUAL CHECK
			1	10	20	30	40	
8	*	Brake hoses • Check for cracks or damage. • Replace. (See NOTE on page 6-4.)		√	√	√	√	√
			Every 4 years					
9	*	Wheels • Check runout and for damage.		√	√	√	√	
10	*	Tires • Check tread depth and for damage. • Replace if necessary. • Check air pressure. • Correct if necessary.		√	√	√	√	
11	*	Wheel bearings • Check bearing for looseness or damage.		√	√	√	√	
12	*	Swingarm • Operation and for excessive play. • Lubricate with lithium-soap-based grease.	Every 50,000 km					
				√	√	√	√	
13	*	Steering bearings • Check bearing play and steering for roughness. • Lubricate with lithium-soap-based grease.	√	√	√	√	√	
			Every 20,000 km					
14	*	Chassis fasteners • Make sure that all nuts, bolts and screws are properly tightened.		√	√	√	√	√
15		Sidestand/centerstand • Check operation. • Lubricate.		√	√	√	√	√
16	*	Sidestand switch • Check operation.	√	√	√	√	√	√
17	*	Front fork • Check operation and for oil leakage.		√	√	√	√	
18	*	Shock absorber assembly • Check operation and shock absorber for oil leakage.		√	√	√	√	
19	*	Rear suspension relay arm and connecting arm pivoting points • Check operation. • Lubricate with lithium-soap-based grease.		√	√	√	√	
					√		√	
20	*	Electronic fuel injection system • Adjust engine idling speed and synchronization.	√	√	√	√	√	√
21		Engine oil • Change.	√	√	√	√	√	√

PERIODIC MAINTENANCE AND MINOR REPAIR

NO.	ITEM	CHECK OR MAINTENANCE JOB	ODOMETER READING (× 1,000 km)					ANNUAL CHECK
			1	10	20	30	40	
22	Engine oil filter cartridge	• Replace.	√		√		√	
23	* Cooling system	• Check coolant level and vehicle for coolant leakage. • Change.		√	√	√	√	√
24	Final gear oil	• Check oil level and vehicle for oil leakage. • Change.	√	√	√	√	√	
25	* Muffler and exhaust pipe	• Check the screw clamp for looseness.	√					
26	* Front and rear brake switches	• Check operation.	√	√	√	√	√	√
27	Moving parts and cables	• Lubricate.		√	√	√	√	√
28	* Lights, signals and switches	• Check operation. • Adjust headlight beam.	√	√	√	√	√	√

EAU03892

NOTE:

- The air filter needs more frequent service if you are riding in unusually wet or dusty areas.
- Hydraulic brake and clutch systems
 - After disassembling the brake or clutch master cylinders, caliper cylinders or clutch release cylinder, always change the fluid. Regularly check the brake and clutch fluid levels and fill the reservoirs as required.
 - Replace the oil seals on the inner parts of the brake or clutch master cylinders, caliper cylinders and clutch release cylinder every two years.
 - Replace the brake and clutch hoses every four years or if cracked or damaged.

PERIODIC MAINTENANCE AND MINOR REPAIR

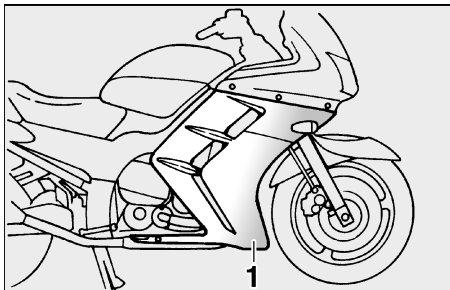

1. Cowling A

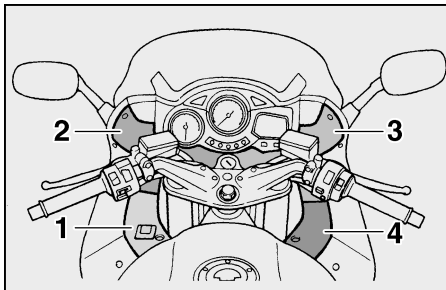

1. Panel A
2. Panel B
3. Panel C
4. Panel D

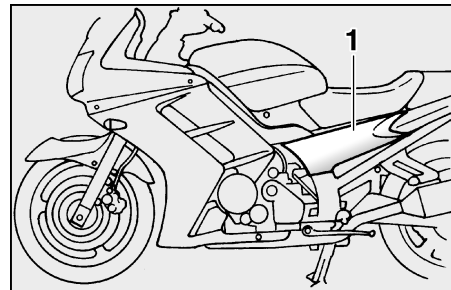

1. Panel E

EAU03516

Removing and installing the cowling and panels

The cowling and panels shown above need to be removed to perform some of the maintenance jobs described in this chapter. Refer to this section each time the cowling or a panel needs to be removed and installed.

PERIODIC MAINTENANCE AND MINOR REPAIR

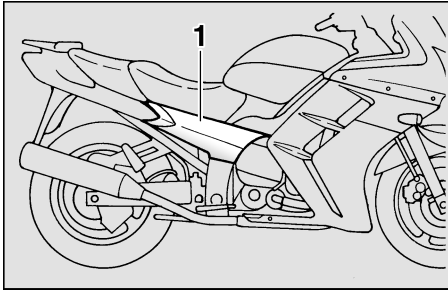

1. Panel F

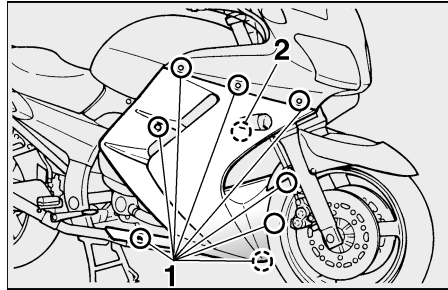

1. Screw (× 9)
2. Quick fastener screw

EAU03536

Cowling A

To remove the cowling

Remove the screw, loosen the quick fastener screws 1/4 turn counterclockwise, and then take the cowling off.

To install the cowling

Place the cowling in the original position, and then tighten the quick fastener screws and install the screw.

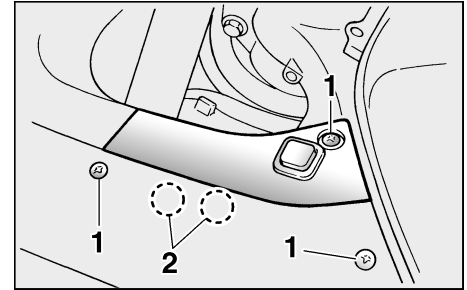

1. Screw (× 3)
2. Quick fastener screw (× 2)

EAU04061

Panel A

To remove the panel

Remove the screws and the quick fastener screws, and then take the panel off.

To install the panel

Place the panel in the original position, and then install the screws and the quick fastener screws.

PERIODIC MAINTENANCE AND MINOR REPAIR

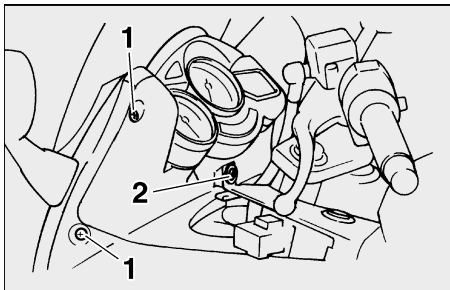

1. Screw (× 2)
2. Quick fastener screw

EAU04062

Panels B and C

To remove one of the panels

1. Remove panel A (if removing panel B) or panel D (if removing panel C).
2. Loosen the quick fastener screw and remove the screws, and then take the panel off.

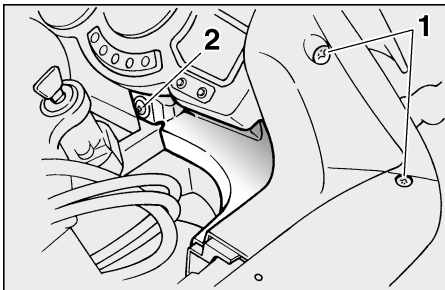

1. Screw (× 2)
2. Quick fastener screw

To install the panel

1. Place the panel in the original position, and then tighten the quick fastener screw and install the screws.
2. Install panel A (to complete the installation of panel B) or panel D (to complete the installation of panel C).

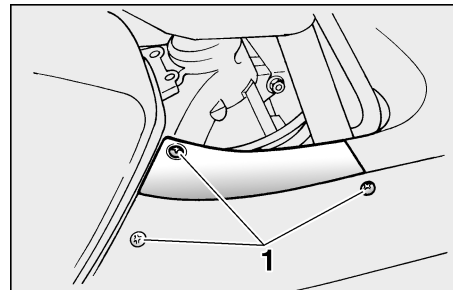

1. Screw (× 3)

EAU01315

Panel D

To remove the panel

Remove the screws, and then take the panel off.

To install the panel

Place the panel in the original position, and then install the screws.

PERIODIC MAINTENANCE AND MINOR REPAIR

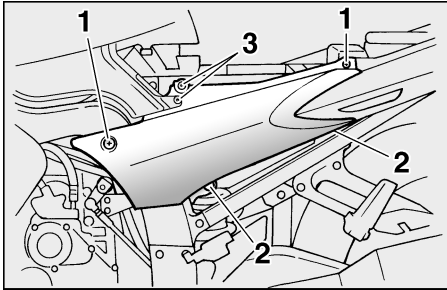

1. Screw (× 2)
2. Quick fastener screw (× 2)
3. Quick fastener (× 2)

Panels E and F

EAU04063

To remove one of the panels

1. Remove the seats. (See page 3-10 for seat removal and installation procedures.)
2. Remove the screws, the quick fastener screws and the quick fasteners, and then take the panel off.

To install the panel

1. Place the panel in the original position, and then install the quick fasteners and quick fastener screws, and tighten the screws.
2. Install the seats.

EAU01880

Checking the spark plugs

The spark plugs are important engine components, which should be checked periodically, preferably by a Yamaha dealer. Since heat and deposits will cause any spark plug to slowly erode, they should be removed and checked in accordance with the periodic maintenance and lubrication chart. In addition, the condition of the spark plugs can reveal the condition of the engine.

The porcelain insulator around the center electrode of each spark plug should be a medium-to-light tan (the ideal color when the motorcycle is ridden normally), and all spark plugs installed in the engine should have the same color. If any spark plug shows a distinctly different color, the engine could be defective. Do not attempt to diagnose such problems yourself. Instead, have a Yamaha dealer check the motorcycle. If a spark plug shows signs of electrode erosion and excessive carbon or other deposits, it should be replaced.

Specified spark plug:
CR8E (NGK) or
U24ESR-N (DENSO)

PERIODIC MAINTENANCE AND MINOR REPAIR

EAU03997

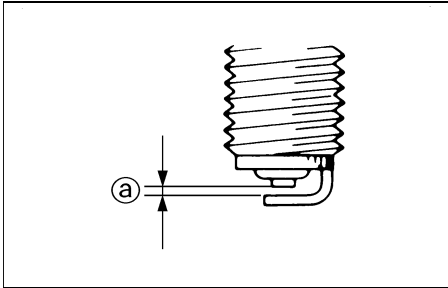

a. Spark plug gap

Before installing a spark plug, the spark plug gap should be measured with a wire thickness gauge and, if necessary, adjusted to specification.

Spark plug gap:
0.7–0.8 mm

Clean the surface of the spark plug gasket and its mating surface, and then wipe off any grime from the spark plug threads.

Tightening torque:
Spark plug:
12.5 Nm (1.25 m·kgf)

NOTE: _____
If a torque wrench is not available when installing a spark plug, a good estimate of the correct torque is 1/4–1/2 turn past finger tight. However, the spark plug should be tightened to the specified torque as soon as possible.

Engine oil and oil filter cartridge

The engine oil level should be checked before each ride. In addition, the oil must be changed and the oil filter cartridge replaced at the intervals specified in the periodic maintenance and lubrication chart.

To check the engine oil level

1. Place the motorcycle on the centerstand.

NOTE: _____
Make sure that the motorcycle is positioned straight up when checking the oil level. A slight tilt to the side can result in a false reading.

2. Start the engine, warm it up for several minutes, and then turn it off.

PERIODIC MAINTENANCE AND MINOR REPAIR

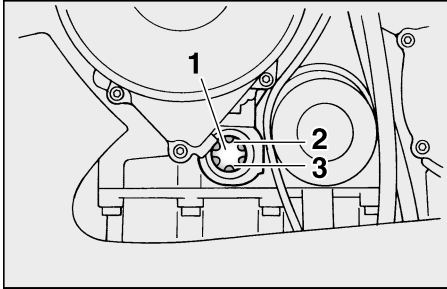

1. Engine oil level check window
2. Maximum level mark
3. Minimum level mark

3. Wait a few minutes until the oil settles, and then check the oil level through the check window located at the bottom-left side of the crankcase.

NOTE: _____
The engine oil should be between the minimum and maximum level marks.

4. If the engine oil is below the minimum level mark, add sufficient oil of the recommended type to raise it to the correct level.

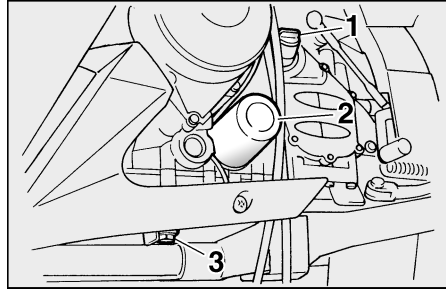

1. Engine oil filler cap
2. Engine oil filter cartridge
3. Engine oil drain bolt

To change the engine oil (with or without oil filter cartridge replacement)

1. Start the engine, warm it up for several minutes, and then turn it off.
2. Place an oil pan under the engine to collect the used oil.
3. Remove the engine oil filler cap and drain bolt to drain the oil from the crankcase.

NOTE: _____
Skip steps 4–6 if the oil filter cartridge is not being replaced.

4. Remove the oil filter cartridge with an oil filter wrench.

NOTE: _____
An oil filter wrench is available at a Yamaha dealer.

5. Apply a thin coat of engine oil to the O-ring of the new oil filter cartridge.

NOTE: _____
Make sure that the O-ring is properly seated.

6. Install the new oil filter cartridge, and then tighten it to the specified torque with a torque wrench.

Tightening torque:
Oil filter cartridge:
17 Nm (1.7 m-kgf)

7. Install the engine oil drain bolt, and then tighten it to the specified torque.

PERIODIC MAINTENANCE AND MINOR REPAIR

EC000072

EC000067

Tightening torque:

Engine oil drain bolt:
43 Nm (4.3 m·kgf)

8. Add the specified amount of the recommended engine oil, and then install and tighten the oil filler cap.

Recommended engine oil:

See page 8-1.

Oil quantity:

Without oil filter cartridge
replacement:

3.8 L

With oil filter cartridge
replacement:

4 L

Total amount (dry engine):

4.9 L

CAUTION:

- In order to prevent clutch slippage (since the engine oil also lubricates the clutch), do not mix any chemical additives with the oil or use oils of a higher grade than “CD”. In addition, do not use oils labeled “ENERGY CONSERVING II” or higher.
- Make sure that no foreign material enters the crankcase.

9. Start the engine, and then let it idle for several minutes while checking it for oil leakage. If oil is leaking, immediately turn the engine off and check for the cause.

NOTE:

After the engine is started, the engine oil level warning light should go off if the oil level is sufficient.

CAUTION:

If the oil level warning light flickers or remains on, immediately turn the engine off and have a Yamaha dealer check the vehicle.

10. Turn the engine off, and then check the oil level and correct it if necessary.

PERIODIC MAINTENANCE AND MINOR REPAIR

Final gear oil

EAU04067

The final gear case must be checked for oil leakage before each ride. If any leakage is found, have a Yamaha dealer check and repair the motorcycle. In addition, the final gear oil must be changed as follows at the intervals specified in the periodic maintenance and lubrication chart.

EW000066

! WARNING

- Make sure that no foreign material enters the final gear case.
- Make sure that no oil gets on the tire or wheel.

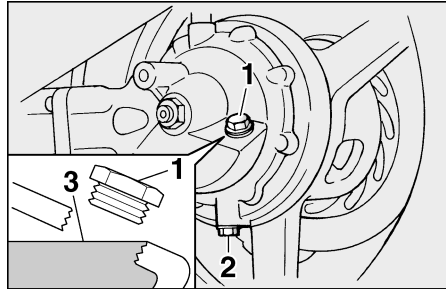

1. Final gear oil filler bolt
2. Final gear oil drain bolt
3. Correct oil level

To check the final gear oil level

1. Place the motorcycle on the centerstand.

NOTE:

- The final gear oil level must be checked on a cold engine.
- Make sure that the motorcycle is positioned straight up when checking the oil level. A slight tilt to the side can result in a false reading.

2. Remove the oil filler bolt, and then check the oil level in the final gear case.

NOTE:

The oil level should be at the brim of the filler hole.

3. If the oil is below the brim of the filler hole, add sufficient oil of the recommended type to raise it to the correct level.

To change the final gear oil

1. Place an oil pan under the final gear case to collect the used oil.
2. Remove the oil filler bolt and drain bolt to drain the oil from the final gear case.
3. Install the final gear oil drain bolt, and then tighten it to the specified torque.

Tightening torque:

Final gear oil drain bolt:
23 Nm (2.3 m·kgf)

4. Add the recommended final gear oil to the brim of the filler hole.

PERIODIC MAINTENANCE AND MINOR REPAIR

Recommended final gear oil:
Shaft drive gear oil
(Part No.: 9079E-SH001-00)
Oil quantity:
0.2 L

5. Install and tighten the filler bolt.
6. Check the final gear case for oil leakage. If oil is leaking, check for the cause.

Checking the coolant level

EAU04044

The coolant level should be checked as follows before each ride. In addition, the coolant must be changed at the intervals specified in the periodic maintenance and lubrication chart.

1. Place the motorcycle on a level surface and hold it in an upright position.

NOTE: _____

- The coolant level must be checked on a cold engine since the level varies with engine temperature.
- Make sure that the motorcycle is positioned straight up when checking the coolant level. A slight tilt to the side can result in a false reading.

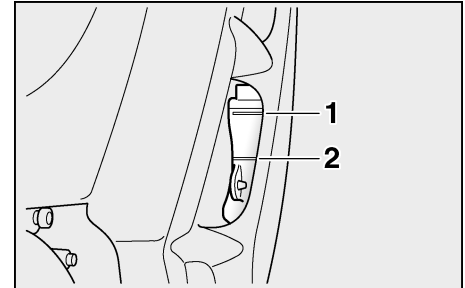

1. Maximum level mark
2. Minimum level mark

2. Check the coolant level in the coolant reservoir.

NOTE: _____

The coolant should be between the minimum and maximum level marks.

PERIODIC MAINTENANCE AND MINOR REPAIR

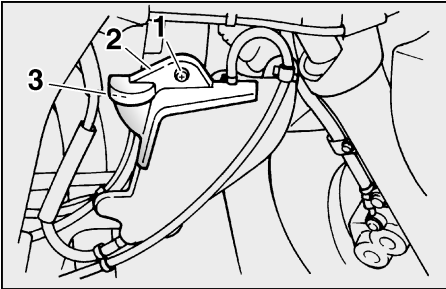

1. Screw
2. Reservoir cap cover
3. Reservoir cap

3. If the coolant is at or below the minimum level mark, remove cowling A (See page 6-6 for cowling removal and installation procedures.), open the reservoir cap, add coolant to the maximum level mark, close the reservoir cap, and then install the cowling.

Coolant reservoir capacity:
0.25 L

EC000080

CAUTION:

- If coolant is not available, use distilled water or soft tap water instead. Do not use hard water or salt water since it is harmful to the engine.
- If water has been used instead of coolant, replace it with coolant as soon as possible, otherwise the engine may not be sufficiently cooled and the cooling system will not be protected against frost and corrosion.
- If water has been added to the coolant, have a Yamaha dealer check the antifreeze content of the coolant as soon as possible, otherwise the effectiveness of the coolant will be reduced.

EW000067

⚠ WARNING

Never attempt to remove the radiator cap when the engine is hot.

NOTE:

- The radiator fan is automatically switched on or off according to the coolant temperature in the radiator.
- If the engine overheats, see page 6-35 for further instructions.

PERIODIC MAINTENANCE AND MINOR REPAIR

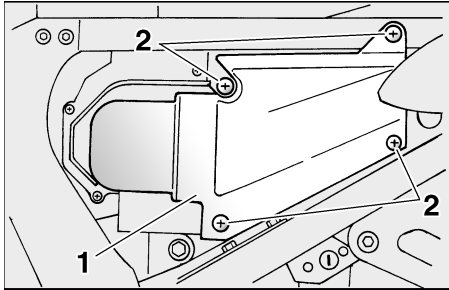

1. Air shroud
2. Quick fastener (× 4)

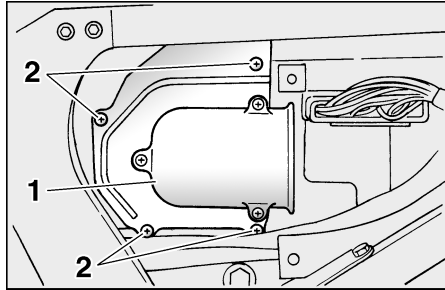

1. Air filter case cover
 2. Screw (× 4)
3. Remove the air filter case cover by removing the screws.

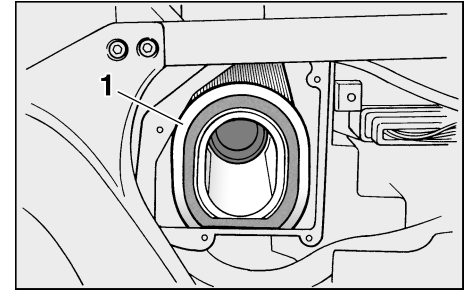

1. Air filter element
4. Pull the air filter element out.

EAU03998*

Cleaning the air filter element

The air filter element should be cleaned at the intervals specified in the periodic maintenance and lubrication chart. Clean the air filter element more frequently if you are riding in unusually wet or dusty areas.

1. Remove panel E. (See page 6-8 for panel removal and installation procedures.)
2. Remove the intake air shroud by removing the quick fasteners.

PERIODIC MAINTENANCE AND MINOR REPAIR

EC000082*

EAU04033

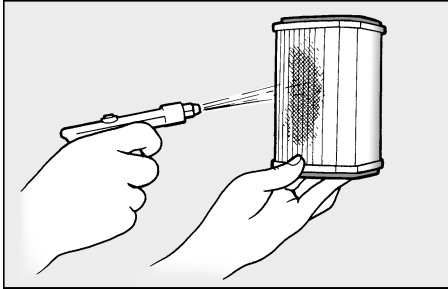

Checking the engine idling speed

The engine idling speed must be checked as follows and, if necessary, adjusted by a Yamaha dealer at the intervals specified in the periodic maintenance and lubrication chart.

Start the engine and warm it up for several minutes at 1,000–2,000 r/min while occasionally revving it to 4,000–5,000 r/min.

NOTE: _____
The engine is warm when it quickly responds to the throttle.

Engine idling speed:
1,000–1,100 r/min

CAUTION: _____

- Make sure that the air filter element is properly seated in the air filter case.
- The engine should never be operated without the air filter element installed, otherwise the pistons and/or cylinders may become excessively worn.

5. Lightly tap the air filter element to remove most of the dust and dirt, and then blow the remaining dirt out with compressed air as shown. If the air filter element is damaged, replace it.
6. Insert the air filter element into the air filter case.

7. Install the air filter case cover by installing the screws.
8. Install the intake air shroud by installing the quick fasteners.
9. Install the panel.

PERIODIC MAINTENANCE AND MINOR REPAIR

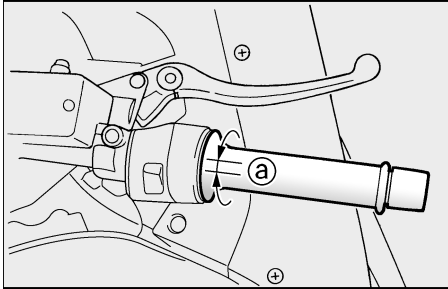

a. Throttle cable free play

EAU00635

Adjusting the throttle cable free play

The throttle cable free play should measure 3–5 mm at the throttle grip. Periodically check the throttle cable free play and, if necessary, have a Yamaha dealer adjust it.

EAU00637

Adjusting the valve clearance

The valve clearance changes with use, resulting in improper air-fuel mixture and/or engine noise. To prevent this from occurring, the valve clearance must be adjusted by a Yamaha dealer at the intervals specified in the periodic maintenance and lubrication chart.

EAU03296

Tires

To maximize the performance, durability, and safe operation of your motorcycle, note the following points regarding the specified tires.

Tire air pressure

The tire air pressure should be checked and, if necessary, adjusted before each ride.

EW000082

⚠ WARNING

- The tire air pressure must be checked and adjusted on cold tires (i.e., when the temperature of the tires equals the ambient temperature).
- The tire air pressure must be adjusted in accordance with the riding speed and with the total weight of rider, passenger, cargo, and accessories approved for this model.

PERIODIC MAINTENANCE AND MINOR REPAIR

EW000083

Tire air pressure (measured on cold tires)		
Load*	Front	Rear
Up to 90 kg	250 kPa (2.50 kgf/cm ² , 2.50 bar)	250 kPa (2.50 kgf/cm ² , 2.50 bar)
90 kg–maximum	250 kPa (2.50 kgf/cm ² , 2.50 bar)	290 kPa (2.90 kgf/cm ² , 2.90 bar)
High-speed riding	250 kPa (2.50 kgf/cm ² , 2.50 bar)	290 kPa (2.90 kgf/cm ² , 2.90 bar)

Maximum load*	208 kg
---------------	--------

* Total weight of rider, passenger, cargo and accessories

⚠ WARNING

Proper loading of your motorcycle is important for several characteristics of your motorcycle, such as handling, braking, performance and safety. Do not carry loosely packed items that can shift. Securely pack your heaviest items close to the center of the motorcycle, and distribute the weight evenly from side to side. Properly adjust the suspension for your load, and check the condition and pressure of your tires. **NEVER OVERLOAD YOUR MOTORCYCLE.** Make sure that the total weight of the cargo, rider, passenger, and accessories (cowling, saddlebags, etc. if approved for this model) does not exceed the maximum load of the motorcycle. Operation of an overloaded motorcycle could cause tire damage, an accident, or even injury.

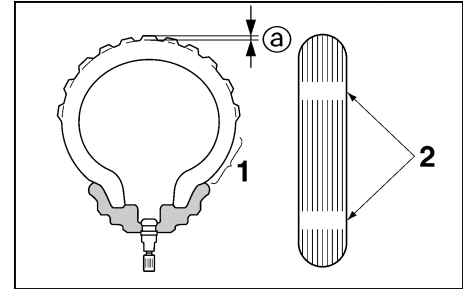

1. Tire sidewall
2. Tire wear indicator
- a. Tire tread depth

Tire inspection

Always check the tires before operating the motorcycle. If a tire tread shows crosswise lines (minimum tread depth), if the tire has a nail or glass fragments in it, or if the sidewall is cracked, contact a Yamaha dealer immediately and have the tire replaced.

PERIODIC MAINTENANCE AND MINOR REPAIR

EW000079

⚠ WARNING

- Have a Yamaha dealer replace excessively worn tires. Besides being illegal, operating the motorcycle with excessively worn tires decreases riding stability and can lead to loss of control.
- The replacement of all wheel- and brake-related parts, including the tires, should be left to a Yamaha dealer, who has the necessary professional knowledge and experience.

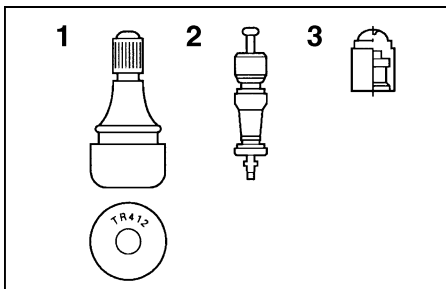

1. Tire air valve
2. Tire air valve core
3. Tire air valve cap with seal

Tire information

This motorcycle is equipped with cast wheels and tubeless tires with valves.

EW000080

⚠ WARNING

- The front and rear tires should be of the same make and design, otherwise the handling characteristics of the motorcycle cannot be guaranteed.
- After extensive tests, only the tires listed below have been approved for this model by Yamaha Motor Co., Ltd.

- Always make sure that the valve caps are securely installed to prevent air pressure leakage.
- Use only the tire valves and valve cores listed below to avoid tire deflation during a high-speed ride.

FRONT

Manufacturer	Size	Model
Metzeler	120/70 ZR17 (58W)	MEZ4B FRONT
Bridgestone	120/70 ZR17 (58W)	BT020FN

REAR

Manufacturer	Size	Model
Metzeler	180/55 ZR17 (73W)	MEZ4J
Bridgestone	180/55 ZR17 (73W)	BT020RN

FRONT & REAR

Tire air valve	TR412
Valve core	#9000A (original)

Minimum tire tread depth
(front and rear)

1.0 mm

NOTE:

The tire tread depth limits may differ from country to country. Always comply with the local regulations.

WARNING

This motorcycle is fitted with super-high-speed tires. Note the following points in order to make the most efficient use of these tires.

- Use only the specified replacement tires. Other tires may run the danger of bursting at super high speeds.
- Brand-new tires can have a relatively poor grip on certain road surfaces until they have been “broken in”. Therefore, it is advisable before doing any high-speed riding to ride conservatively for approximately 100 km after installing a new tire.
- The tires must be warmed up before a high-speed run.
- Always adjust the tire air pressure according to the operating conditions.

Cast wheels

To maximize the performance, durability, and safe operation of your motorcycle, note the following points regarding the specified wheels.

- The wheel rims should be checked for cracks, bends or warpage before each ride. If any damage is found, have a Yamaha dealer replace the wheel. Do not attempt even the smallest repair to the wheel. A deformed or cracked wheel must be replaced.
- The wheel should be balanced whenever either the tire or wheel has been changed or replaced. An unbalanced wheel can result in poor performance, adverse handling characteristics, and a shortened tire life.
- Ride at moderate speeds after changing a tire since the tire surface must first be “broken in” for it to develop its optimal characteristics.

Clutch lever free play

Since this model is equipped with a hydraulic clutch, adjusting the clutch lever free play is not needed. However, it is necessary to check the clutch fluid level and check the hydraulic system for leakage before each ride. If the clutch lever free play does become excessive, and shifting becomes rough or clutch slippage occurs, causing poor acceleration, there may be air in the clutch system. If there is air in the hydraulic system, have a Yamaha dealer bleed the system before operating the motorcycle.

PERIODIC MAINTENANCE AND MINOR REPAIR

EW000109

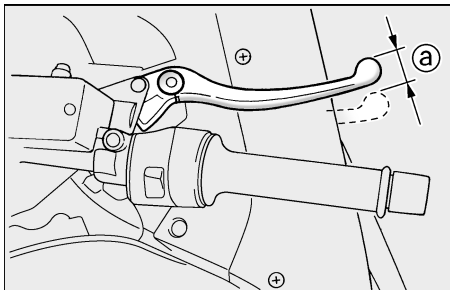

a. Brake lever free play

EAU00697

Adjusting the brake lever free play

The brake lever free play should measure 3–11 mm as shown. Periodically check the brake lever free play and, if necessary, have a Yamaha dealer adjust it.

EW000100

! WARNING

An incorrect brake lever free play indicates a hazardous condition in the brake system. Do not operate the motorcycle until the brake system has been checked or repaired by a Yamaha dealer.

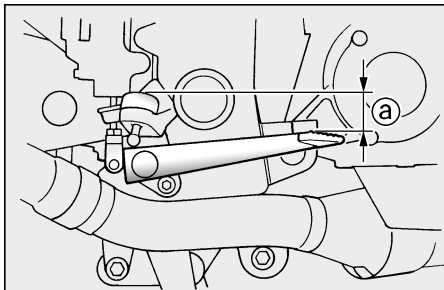

a. Distance between brake pedal and footrest

EAU00712

Adjusting the brake pedal position

The top of the brake pedal should be positioned approximately 40 mm below the top of the footrest as shown. Periodically check the brake pedal position and, if necessary, have a Yamaha dealer adjust it.

! WARNING

A soft or spongy feeling in the brake pedal can indicate the presence of air in the hydraulic system. If there is air in the hydraulic system, have a Yamaha dealer bleed the system before operating the motorcycle. Air in the hydraulic system will diminish the braking performance, which may result in loss of control and an accident.

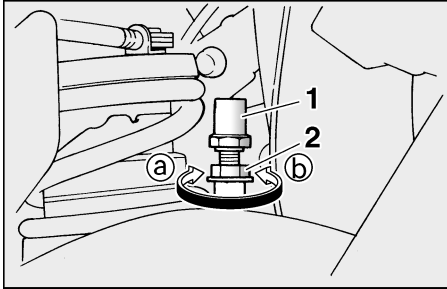

1. Rear brake light switch
2. Rear brake light switch adjusting nut

EAU00713

Adjusting the rear brake light switch

The rear brake light switch, which is activated by the brake pedal, is properly adjusted when the brake light comes on just before braking takes effect. If necessary, adjust the brake light switch as follows.

Turn the adjusting nut while holding the rear brake light switch in place. To make the brake light come on earlier, turn the adjusting nut in direction Ⓐ. To make the brake light come on later, turn the adjusting nut in direction Ⓑ.

EAU00721

Checking the front and rear brake pads

The front and rear brake pads must be checked for wear at the intervals specified in the periodic maintenance and lubrication chart.

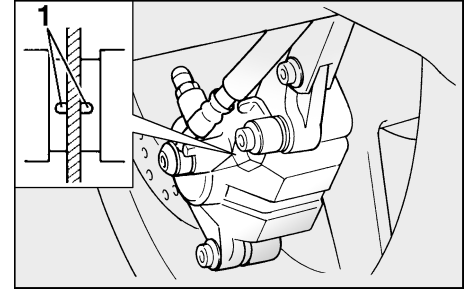

1. Brake pad wear indicator groove (x 2)

EAU00725

Front brake pads

Each front brake pad is provided with a wear indicator groove, which allows you to check the brake pad wear without having to disassemble the brake. To check the brake pad wear, check the wear indicator groove. If a brake pad has worn to the point that the wear indicator groove has almost disappeared, have a Yamaha dealer replace the brake pads as a set.

PERIODIC MAINTENANCE AND MINOR REPAIR

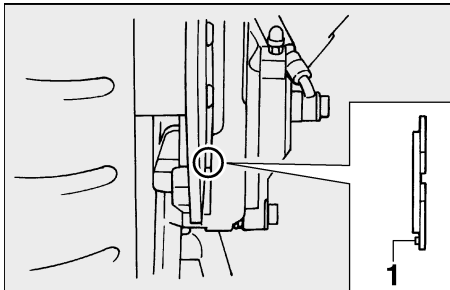

1. Brake pad wear indicator

EAU00728

Rear brake pads

Each rear brake pad is provided with a wear indicator, which allows you to check the brake pad wear without having to disassemble the brake. To check the brake pad wear, check the position of the wear indicator while applying the brake. If a brake pad has worn to the point that the wear indicator almost touches the brake disc, have a Yamaha dealer replace the brake pads as a set.

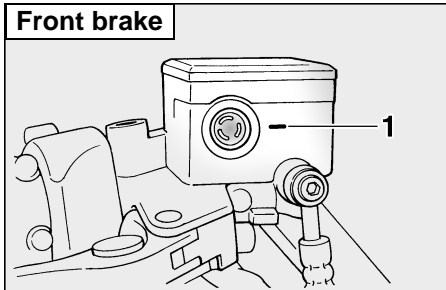

1. Minimum level mark

EAU04098

Checking the brake and clutch fluid levels

Insufficient brake fluid may allow air to enter the brake or clutch systems, possibly causing them to become ineffective. Before riding, check that the brake fluid is above the minimum level mark and replenish if necessary. A low brake fluid level may indicate worn brake pads and/or brake system leakage. If the brake level is low, be sure to check the brake pads for wear and the brake system for leakage.

NOTE:

The rear brake fluid reservoir is located behind panel F. (See page 6-8 for panel removal and installation procedures.)

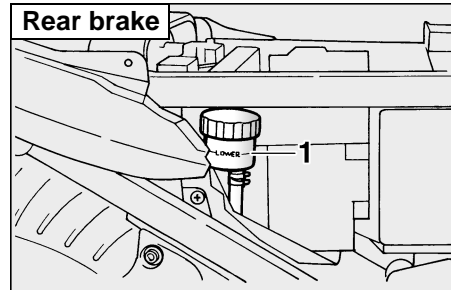

1. Minimum level mark

Observe these precautions:

- When checking the fluid level, make sure that the top of the brake or clutch fluid reservoir is level.
- Use only the recommended quality brake fluid, otherwise the rubber seals may deteriorate, causing leakage and poor braking or clutch performance.

Recommended brake and clutch fluid: DOT 4 brake fluid

- Refill with the same type of brake fluid. Mixing fluids may result in a harmful chemical reaction and lead to poor braking or clutch performance.

EAU03984

EAU02962

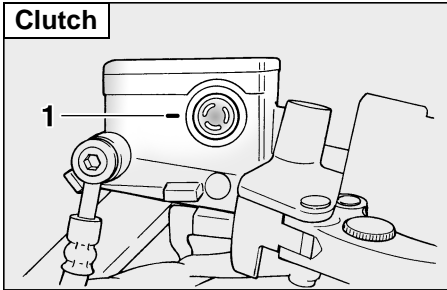

1. Minimum level mark

Changing the brake and clutch fluids

Have a Yamaha dealer change the brake and clutch fluids at the intervals specified in the NOTE after the periodic maintenance and lubrication chart. In addition, have the oil seals of the brake and clutch master cylinders and calipers as well as the brake and clutch hoses replaced at the intervals listed below or whenever they are damaged or leaking.

- Be careful that water does not enter the brake or clutch fluid reservoir when refilling. Water will significantly lower the boiling point of the fluid and may result in vapor lock.
- Brake fluid may deteriorate painted surfaces or plastic parts. Always clean up spilled fluid immediately.
- As the brake pads wear, it is normal for the brake fluid level to gradually go down. However, if the brake fluid level goes down suddenly, have a Yamaha dealer check the cause.

- Oil seals: Replace every two years.
- Brake and clutch hoses: Replace every four years.

Checking and lubricating the cables

The operation of all control cables and the condition of the cables should be checked before each ride, and the cables and cable ends should be lubricated if necessary. If a cable is damaged or does not move smoothly, have a Yamaha dealer check or replace it.

Recommended lubricant:
Engine oil

EW000112

WARNING

Damage to the outer sheath may interfere with proper cable operation and will cause the inner cable to rust. Replace a damaged cable as soon as possible to prevent unsafe conditions.

PERIODIC MAINTENANCE AND MINOR REPAIR

Checking and lubricating the throttle grip and cable

EAU04034

The operation of the throttle grip should be checked before each ride. In addition, the cable should be lubricated or replaced at the intervals specified in the periodic maintenance chart.

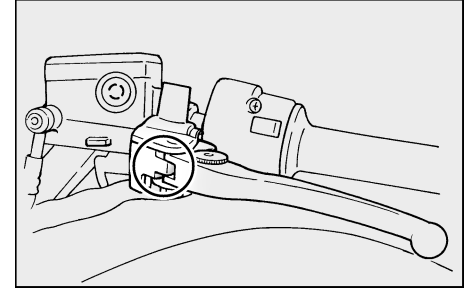
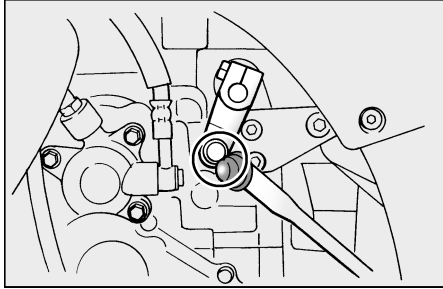

Checking and lubricating the brake and shift pedals

EAU03370

The operation of the brake and shift pedals should be checked before each ride, and the pedal pivots should be lubricated if necessary.

Recommended lubricant:
Lithium-soap-based grease
(all-purpose grease)

Checking and lubricating the brake and clutch levers

EAU03164

The operation of the brake and clutch levers should be checked before each ride, and the lever pivots should be lubricated if necessary.

Recommended lubricant:
Lithium-soap-based grease
(all-purpose grease)

PERIODIC MAINTENANCE AND MINOR REPAIR

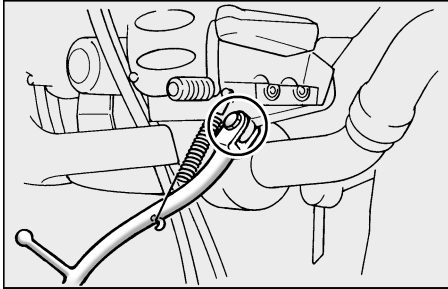

Recommended lubricant:
Lithium-soap-based grease
(all-purpose grease)

Checking and lubricating the centerstand and sidestand

EAU03371

The operation of the centerstand and sidestand should be checked before each ride, and the pivots and metal-to-metal contact surfaces should be lubricated if necessary.

EW000114

⚠ WARNING

If the centerstand or sidestand does not move up and down smoothly, have a Yamaha dealer check or repair it.

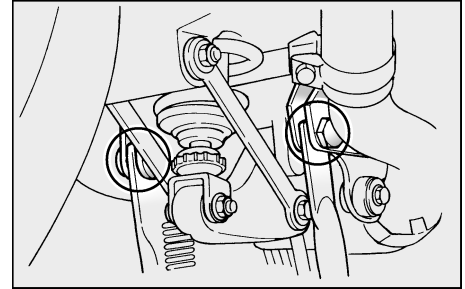

Lubricating the rear suspension

EAU03166

The pivoting points of the rear suspension must be lubricated at the intervals specified in the periodic maintenance and lubrication chart.

Recommended lubricant:
Lithium-soap-based grease
(all-purpose grease)

PERIODIC MAINTENANCE AND MINOR REPAIR

Checking the front fork

EAU02939

The condition and operation of the front fork must be checked as follows at the intervals specified in the periodic maintenance and lubrication chart.

To check the condition

EW000115

⚠ WARNING

Securely support the motorcycle so that there is no danger of it falling over.

Check the inner tubes for scratches, damage and excessive oil leakage.

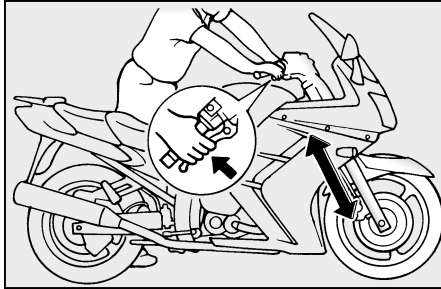

To check the operation

1. Place the motorcycle on a level surface and hold it in an upright position.
2. While applying the front brake, push down hard on the handlebars several times to check if the front fork compresses and rebounds smoothly.

EC000098

CAUTION:

If any damage is found or the front fork does not operate smoothly, have a Yamaha dealer check or repair it.

EAU00794

Checking the steering

Worn or loose steering bearings may cause danger. Therefore, the operation of the steering must be checked as follows at the intervals specified in the periodic maintenance and lubrication chart.

1. Place a stand under the engine to raise the front wheel off the ground.

EW000115

⚠ WARNING

Securely support the motorcycle so that there is no danger of it falling over.

PERIODIC MAINTENANCE AND MINOR REPAIR

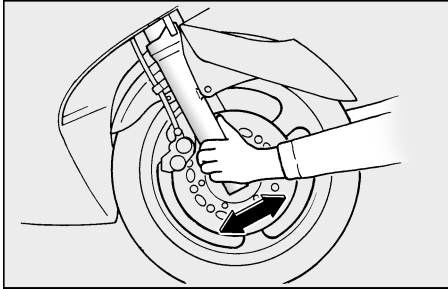

EAU01144

Checking the wheel bearings

The front and rear wheel bearings must be checked at the intervals specified in the periodic maintenance and lubrication chart. If there is play in the wheel hub or if the wheel does not turn smoothly, have a Yamaha dealer check the wheel bearings.

2. Hold the lower ends of the front fork legs and try to move them forward and backward. If any free play can be felt, have a Yamaha dealer check or repair the steering.

PERIODIC MAINTENANCE AND MINOR REPAIR

EW000116

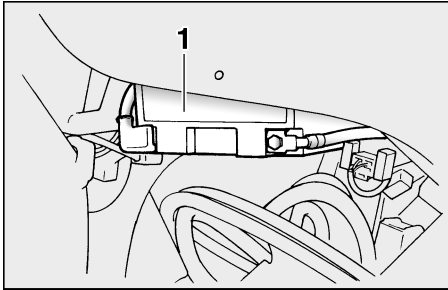

1. Battery

EAU04035

Battery

The battery is located under panel D. (See page 6-7 for panel removal and installation procedures.)

This motorcycle is equipped with a sealed-type (MF) battery, which does not require any maintenance. There is no need to check the electrolyte or to add distilled water.

To charge the battery

Have a Yamaha dealer charge the battery as soon as possible if it seems to have discharged. Keep in mind that the battery tends to discharge more quickly if the motorcycle is equipped with optional electrical accessories.

! WARNING

- **Electrolyte is poisonous and dangerous since it contains sulfuric acid, which causes severe burns. Avoid any contact with skin, eyes or clothing and always shield your eyes when working near batteries. In case of contact, administer the following FIRST AID.**
 - **EXTERNAL:** Flush with plenty of water.
 - **INTERNAL:** Drink large quantities of water or milk and immediately call a physician.
 - **EYES:** Flush with water for 15 minutes and seek prompt medical attention.
- **Batteries produce explosive hydrogen gas. Therefore, keep sparks, flames, cigarettes, etc., away from the battery and provide sufficient ventilation when charging it in an enclosed space.**

- **KEEP THIS AND ALL BATTERIES OUT OF THE REACH OF CHILDREN.**

To store the battery

1. If the motorcycle will not be used for more than one month, remove the battery, fully charge it, and then place it in a cool, dry place.
2. If the battery will be stored for more than two months, check it at least once a month and fully charge it if necessary.
3. Fully charge the battery before installation.

PERIODIC MAINTENANCE AND MINOR REPAIR

EC000102

CAUTION:

- Always keep the battery charged. Storing a discharged battery can cause permanent battery damage.
- To charge a sealed-type (MF) battery, a special (constant-voltage) battery charger is required. Using a conventional battery charger will damage the battery. If you do not have access to a sealed-type (MF) battery charger, have a Yamaha dealer charge your battery.

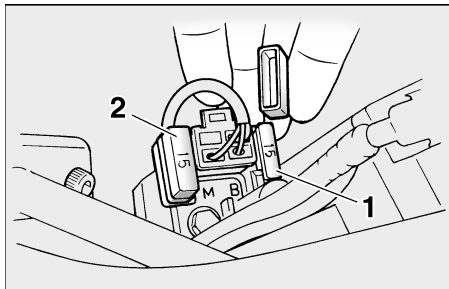

1. Fuel injection system fuse
2. Spare fuel injection system fuse

EAU04076*

Replacing the fuses

The fuse box, which contains the fuses for the individual circuits, is located under panel D. The fuel injection system fuse box is located under panel D. The main fuse box is also located under panel D, beside the battery. (See page 6-7 for panel removal and installation procedures.)

If a fuse is blown, replace it as follows.

1. Turn the key to "OFF" and turn off the electrical circuit in question.
2. Remove the blown fuse, and then install a new fuse of the specified amperage.

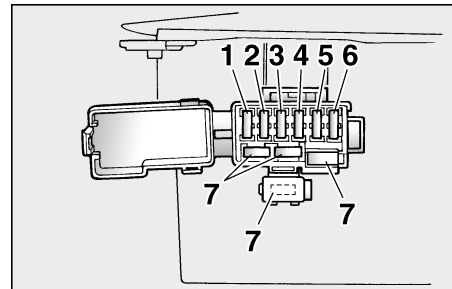

1. Headlight fuse
2. Signaling system fuse
3. Ignition fuse
4. Windshield motor fuse
5. Radiator fan fuse
6. Backup fuse (odometer and clock)
7. Spare fuse (x 4)

PERIODIC MAINTENANCE AND MINOR REPAIR

EC000103

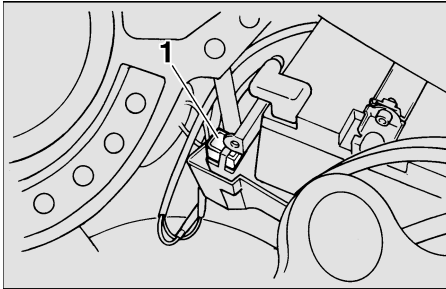

1. Main fuse

Specified fuses:

Main fuse:	50 A
Headlight fuse:	25 A
Signaling system fuse:	15 A
Ignition fuse:	10 A
Windshield motor fuse:	2 A
Radiator fan fuse:	15 A
Backup fuse (odometer and clock):	10 A
Fuel injection system fuse:	15 A

CAUTION:

Do not use a fuse of a higher amperage rating than recommended to avoid causing extensive damage to the electrical system and possibly a fire.

3. Turn the key to "ON" and turn on the electrical circuit in question to check if the device operates.
4. If the fuse immediately blows again, have a Yamaha dealer check the electrical system.

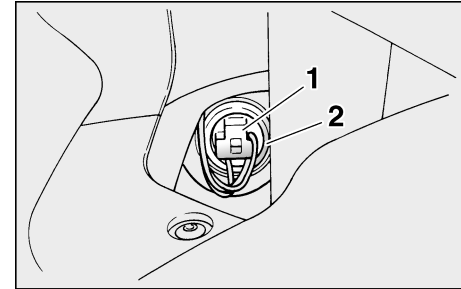

1. Headlight coupler
2. Headlight bulb cover

EAU04099

Replacing a headlight bulb

This motorcycle is equipped with quartz bulb headlights. If a headlight bulb burns out, replace it as follows.

1. Remove panel B (if replacing the left headlight bulb) or panel C (if replacing the right headlight bulb). (See page 6-7 for panel removal and installation procedures.)
2. Disconnect the headlight coupler, and then remove the headlight bulb cover.

PERIODIC MAINTENANCE AND MINOR REPAIR

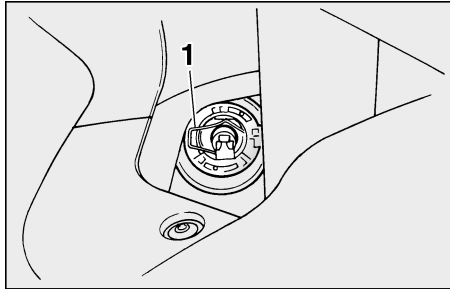

1. Headlight bulb holder

3. Unhook the headlight bulb holder, and then remove the defective bulb.

EW000119

WARNING

Headlight bulbs get very hot. Therefore, keep flammable products away from a lit headlight bulb, and do not touch the bulb until it has cooled down.

4. Place a new bulb into position, and then secure it with the bulb holder.

EC000104

CAUTION:

Take care not to damage the following parts:

- **Headlight bulb**

Do not touch the glass part of the headlight bulb to keep it free from oil, otherwise the transparency of the glass, the luminosity of the bulb, and the bulb life will be adversely affected. Thoroughly clean off any dirt and fingerprints on the headlight bulb using a cloth moistened with alcohol or thinner.

- **Headlight lens**

- Do not affix any type of tinted film or stickers to the headlight lens.
- Do not use a headlight bulb of a wattage higher than specified.

5. Install the bulb cover, and then connect the coupler.
6. Install the panel.
7. Have a Yamaha dealer adjust the headlight beam if necessary.

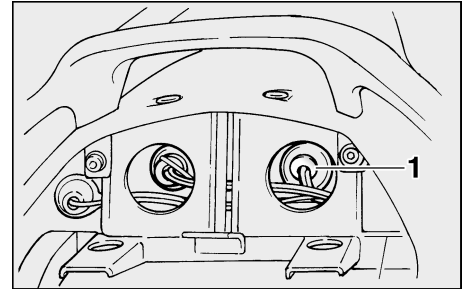

1. Socket

EAU04000

Replacing a tail/brake light bulb

1. Remove the passenger seat. (See page 3-10 for passenger seat removal and installation procedures.)
2. Remove the socket (together with the bulb) by turning it counterclockwise.
3. Remove the defective bulb by turning it counterclockwise.
4. Insert a new bulb into the socket, and then turn it clockwise until it stops.
5. Install the socket (together with the bulb) by turning it clockwise.
6. Install the passenger seat.

PERIODIC MAINTENANCE AND MINOR REPAIR

EAU03087

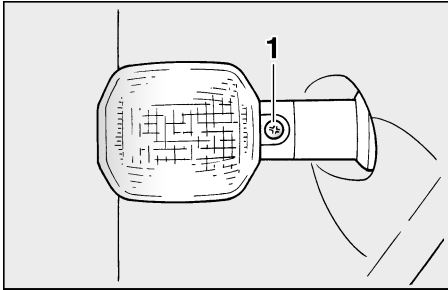

1. Screw

EAU03497

Replacing a turn signal light bulb

1. Remove the turn signal light lens by removing the screw.
2. Remove the defective bulb by pushing it in and turning it counter-clockwise.
3. Insert a new bulb into the socket, push it in, and then turn it clockwise until it stops.
4. Install the lens by installing the screw.

ECA00065

CAUTION:

Do not overtighten the screw, otherwise the lens may break.

Troubleshooting

Although Yamaha motorcycles receive a thorough inspection before shipment from the factory, trouble may occur during operation. Any problem in the fuel, compression, or ignition systems, for example, can cause poor starting and loss of power.

The following troubleshooting charts represent quick and easy procedures for checking these vital systems yourself. However, should your motorcycle require any repair, take it to a Yamaha dealer, whose skilled technicians have the necessary tools, experience, and know-how to service the motorcycle properly.

Use only genuine Yamaha replacement parts. Imitation parts may look like Yamaha parts, but they are often inferior, have a shorter service life and can lead to expensive repair bills.

PERIODIC MAINTENANCE AND MINOR REPAIR

EAU02990

Troubleshooting charts

Starting problems or poor engine performance

EW000125



WARNING

Keep away open flames and do not smoke while checking or working on the fuel system.

1. Fuel

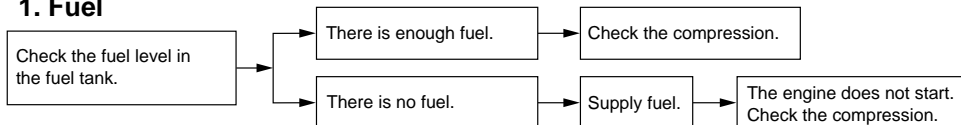

2. Compression

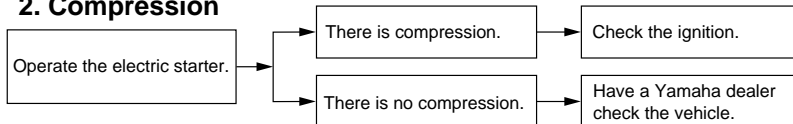

3. Ignition

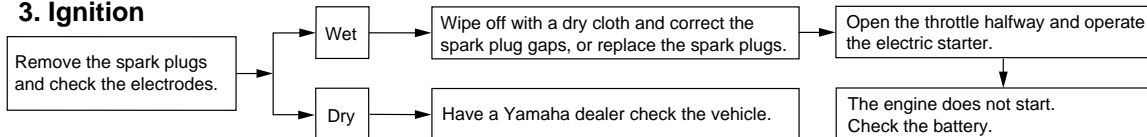

4. Battery

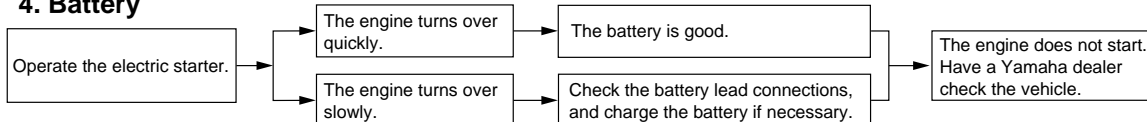

PERIODIC MAINTENANCE AND MINOR REPAIR

Engine overheating

EW000070

! WARNING

- Do not remove the radiator cap when the engine and radiator are hot. Scalding hot fluid and steam may be blown out under pressure, which could cause serious injury. Be sure to wait until the engine has cooled.
- After removing the radiator cap retaining bolt, place a thick rag, like a towel, over the radiator cap, and then slowly rotate the cap counterclockwise to the detent to allow any residual pressure to escape. When the hissing sound has stopped, press down on the cap while turning it counterclockwise, and then remove the cap.

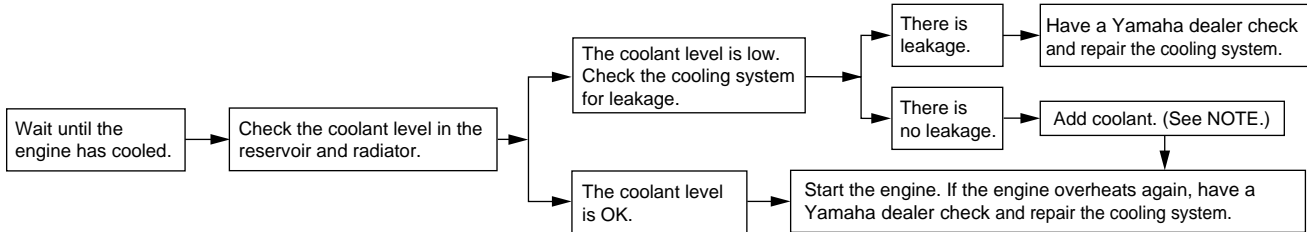

NOTE:

If coolant is not available, tap water can be temporarily used instead, provided that it is changed to the recommended coolant as soon as possible.

MOTORCYCLE CARE AND STORAGE

Care	7-1
Storage	7-4

Care

While the open design of a motorcycle reveals the attractiveness of the technology, it also makes it more vulnerable. Rust and corrosion can develop even if high-quality components are used. A rusty exhaust pipe may go unnoticed on a car, however, it detracts from the overall appearance of a motorcycle. Frequent and proper care does not only comply with the terms of the warranty, but it will also keep your motorcycle looking good, extend its life and optimize its performance.

Before cleaning

1. Cover the muffler outlets with plastic bags after the engine has cooled down.
2. Make sure that all caps and covers as well as all electrical couplers and connectors, including the spark plug caps, are tightly installed.
3. Remove extremely stubborn dirt, like oil burnt onto the crankcase, with a degreasing agent and a brush, but never apply such products onto seals, gaskets and wheel axles. Always rinse the dirt and degreaser off with water.

Cleaning

ECA00010

CAUTION:

- **Avoid using strong acidic wheel cleaners, especially on spoked wheels. If such products are used on hard-to-remove dirt, do not leave the cleaner on the affected area any longer than instructed. Also, thoroughly rinse the area off with water, immediately dry it, and then apply a corrosion protection spray.**
- **Improper cleaning can damage windshields, cowlings, panels and other plastic parts. Use only a soft, clean cloth or sponge with mild detergent and water to clean plastic.**

MOTORCYCLE CARE AND STORAGE

- Do not use any harsh chemical products on plastic parts. Be sure to avoid using cloths or sponges which have been in contact with strong or abrasive cleaning products, solvent or thinner, fuel (gasoline), rust removers or inhibitors, brake fluid, antifreeze or electrolyte.
- Do not use high-pressure washers or steam-jet cleaners since they cause water seepage and deterioration in the following areas: seals (of wheel and swing-arm bearings, fork and brakes), electric components (couplers, connectors, instruments, switches and lights), breather hoses and vents.
- For motorcycles equipped with a windshield: Do not use strong cleaners or hard sponges as they will cause dulling or scratching. Some cleaning compounds for plastic may leave scratches on the windshield. Test the product on a small hidden part of the windshield to make sure that it does not leave any marks. If the windshield is scratched, use a quality plastic polishing compound after washing.

After normal use

Remove dirt with warm water, a mild detergent, and a soft, clean sponge, and then rinse thoroughly with clean water. Use a toothbrush or bottlebrush for hard-to-reach areas. Stubborn dirt and insects will come off more easily if the area is covered with a wet cloth for a few minutes before cleaning.

After riding in the rain, near the sea or on salt-sprayed roads

Since sea salt or salt sprayed on roads during winter are extremely corrosive in combination with water, carry out the following steps after each ride in the rain, near the sea or on salt-sprayed roads.

NOTE: _____
Salt sprayed on roads in the winter may remain well into spring.

1. Clean the motorcycle with cold water and a mild detergent, after the engine has cooled down.

ECA00012

CAUTION: _____
Do not use warm water since it increases the corrosive action of the salt.

2. After drying the motorcycle, apply a corrosion protection spray on all metal, including chrome- and nickel-plated, surfaces to prevent corrosion.

MOTORCYCLE CARE AND STORAGE

After cleaning

1. Dry the motorcycle with a chamois or an absorbing cloth.
2. Use a chrome polish to shine chrome, aluminum and stainless-steel parts, including the exhaust system. (Even the thermally induced discoloring of stainless-steel exhaust systems can be removed through polishing.)
3. To prevent corrosion, it is recommended to apply a corrosion protection spray on all metal, including chrome- and nickel-plated, surfaces.
4. Use spray oil as a universal cleaner to remove any remaining dirt.
5. Touch up minor paint damage caused by stones, etc.
6. Wax all painted surfaces.
7. Let the motorcycle dry completely before storing or covering it.

EWA00031

WARNING

- Make sure that there is no oil or wax on the brakes or tires.
- If necessary, clean the brake discs and brake linings with a regular brake disc cleaner or acetone, and wash the tires with warm water and a mild detergent. Before riding at higher speeds, test the motorcycle's braking performance and cornering behavior.

ECA00013

CAUTION:

- Apply spray oil and wax sparingly and make sure to wipe off any excess.
- Never apply oil or wax to any rubber and plastic parts, but treat them with a suitable care product.
- Avoid using abrasive polishing compounds as they will wear away the paint.

NOTE:

Consult a Yamaha dealer for advice on what products to use.

MOTORCYCLE CARE AND STORAGE

Storage

Short-term

Always store your motorcycle in a cool, dry place and, if necessary, protect it against dust with a porous cover.

ECA00014

CAUTION:

- **Storing the motorcycle in a poorly ventilated room or covering it with a tarp, while it is still wet, will allow water and humidity to seep in and cause rust.**
- **To prevent corrosion, avoid damp cellars, stables (because of the presence of ammonia) and areas where strong chemicals are stored.**

Long-term

Before storing your motorcycle for several months:

1. Follow all the instructions in the “Care” section of this chapter.
2. For motorcycles equipped with a fuel cock that has an “OFF” position: Turn the fuel cock lever to “OFF”.
3. Fill up the fuel tank and add fuel stabilizer (if available) to prevent the fuel tank from rusting and the fuel from deteriorating.
4. Perform the following steps to protect the cylinders, piston rings, etc. from corrosion.

- a. Remove the spark plug caps and spark plugs.
- b. Pour a teaspoonful of engine oil into each spark plug bore.
- c. Install the spark plug caps onto the spark plugs, and then place the spark plugs on the cylinder head so that the electrodes are grounded. (This will limit sparking during the next step.)
- d. Turn the engine over several times with the starter. (This will coat the cylinder walls with oil.)
- e. Remove the spark plug caps from the spark plugs, and then install the spark plugs and the spark plug caps.

EWA00003

WARNING

To prevent damage or injury from sparking, make sure to ground the spark plug electrodes while turning the engine over.

MOTORCYCLE CARE AND STORAGE

5. Lubricate all control cables and the pivoting points of all levers and pedals as well as of the sidestand/centerstand.
6. Check and, if necessary, correct the tire air pressure, and then lift the motorcycle so that both of its wheels are off the ground. Alternatively, turn the wheels a little every month in order to prevent the tires from becoming degraded in one spot.
7. Cover the muffler outlets with plastic bags to prevent moisture from entering them.
8. Remove the battery and fully charge it. Store it in a cool, dry place and charge it once a month. Do not store the battery in an excessively cold or warm place (less than 0 °C or more than 30 °C). For more information on storing the battery, see page 6-29.

NOTE: _____
Make any necessary repairs before storing the motorcycle.

Specifications 8-1
Conversion table 8-5

Specifications

Model	FJR1300
Dimensions	
Overall length	2,195 mm
Overall width	760 mm
Overall height	1,420 mm
Seat height	805 mm
Wheelbase	1,515 mm
Ground clearance	135 mm
Minimum turning radius	3,100 mm
Basic weight (with oil and full fuel tank)	268 kg
Engine	
Engine type	Liquid-cooled 4-stroke, DOHC
Cylinder arrangement	Forward-inclined parallel 4-cylinder
Displacement	1,298 cm ³
Bore × stroke	79.0 × 66.2 mm
Compression ratio	10.8:1
Starting system	Electric starter
Lubrication system	Wet sump

Engine oil

Type

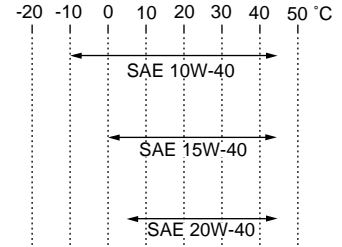

Recommended engine oil classification

API Service SE, SF, SG or higher

CAUTION:

Be sure to use motor oils that do not contain anti-friction modifiers. Passenger car motor oils (often labeled "ENERGY CONSERVING II") contain anti-friction additives which will cause clutch and/or starter clutch slippage, resulting in reduced component life and poor engine performance.

Quantity

Without oil filter cartridge replacement	3.8 L
With oil filter cartridge replacement	4 L
Total amount (dry engine)	4.9 L

Final gear oil

Type Shaft drive gear oil
(Part No.: 9079E-SH001-00)

Quantity 0.2 L

Cooling system capacity (total amount)

3.3 L

Air filter

Dry type element

Fuel

Type Unleaded fuel only

Fuel tank capacity 25 L

Fuel reserve amount 5 L

Spark plug

Manufacturer/model NGK / CR8E or
DENSO / U24ESR-N

Gap 0.7–0.8 mm

Clutch type

Wet, multiple-disc

Transmission

Primary reduction system Helical gear

Primary reduction ratio 1.563

Secondary reduction system Shaft drive

Secondary reduction ratio 2.773

Transmission type Constant-mesh 5-speed

Operation Left foot

Gear ratio

1st 2.529

2nd 1.773

3rd 1.348

4th 1.077

5th 0.929

Chassis

Frame type Diamond

Caster angle 26°

Trail 109 mm

Tires

Front

Type Tubeless tire

Size 120/70 ZR17 (58 W)

Manufacturer/model Metzeler / MEZ4B FRONT

Bridgestone / BT020FN

Rear

Type Tubeless tire

Size 180/55 ZR17 (73 W)

Manufacturer/model Metzeler / MEZ4J

Bridgestone / BT020RN

SPECIFICATIONS

Maximum load*	208 kg
Tire air pressure (measured on cold tires)	
Up to 90 kg*	
Front	250 kPa (2.50 kgf/cm ² , 2.50 bar)
Rear	250 kPa (2.50 kgf/cm ² , 2.50 bar)
90 kg–maximum*	
Front	250 kPa (2.50 kgf/cm ² , 2.50 bar)
Rear	290 kPa (2.90 kgf/cm ² , 2.90 bar)
High-speed riding	
Front	250 kPa (2.50 kgf/cm ² , 2.50 bar)
Rear	290 kPa (2.90 kgf/cm ² , 2.90 bar)

* Total weight of rider, passenger, cargo and accessories

Wheels

Front	
Type	Cast wheel
Size	17 × MT 3.50
Rear	
Type	Cast wheel
Size	17 × MT 5.50

Brakes

Front	
Type	Dual disc brake
Operation	Right hand
Fluid	DOT 4

Rear	
Type	Single disc brake
Operation	Right foot
Fluid	DOT 4

Suspension

Front	Telescopic fork
Rear	Swingarm (link suspension)

Spring/shock absorber

Front	Coil spring / oil damper
Rear	Coil spring / gas-oil damper

Wheel travel

Front	135 mm
Rear	125 mm

Electrical system

Ignition system	Transistorized coil ignition (digital)
Charging system	
Type	A.C. magneto
Standard output	14 V, 490 W@ 5,000 r/min
Battery	
Model	GT14B-4
Voltage, capacity	12 V, 12 Ah

Headlight type

Quartz bulb (halogen)

Bulb voltage, wattage × quantity

Headlight	12 V, 60/55 W × 2
Tail/brake light	12 V, 5/21 W × 2
Turn signal light	12 V, 21 W × 4
Meter lighting	14 V, 1.12 W × 4
Neutral indicator light	14 V, 1.12 W × 1
High beam indicator light	14 V, 1.12 W × 1
Turn signal indicator light	14 V, 1.4 W × 2
Engine trouble warning light	14 V, 1.12 W × 1
Oil level warning light	14 V, 1.12 W × 1

Fuses

Main fuse	50 A
Fuel injection system fuse	15 A
Headlight fuse	25 A
Signaling system fuse	15 A
Radiator fan fuse	15 A
Ignition fuse	10 A
Backup fuse (odometer and clock)	10 A
Windshield motor fuse	2 A

SPECIFICATIONS

EAU03941

Conversion table

All specification data in this manual are listed in SI and METRIC UNITS.

Use this table to convert METRIC unit values to IMPERIAL unit values.

Example:

METRIC VALUE	CONVERSION FACTOR		IMPERIAL VALUE
2 mm	× 0.03937	=	0.08 in

Conversion table

METRIC SYSTEM TO IMPERIAL SYSTEM			
	Metric unit	Conversion factor	Imperial unit
Torque	m·kgf	× 7.233	ft·lb
	m·kgf	× 86.794	in·lb
	cm·kgf	× 0.0723	ft·lb
	cm·kgf	× 0.8679	in·lb
Weight	kg	× 2.205	lb
	g	× 0.03527	oz
Speed	km/h	× 0.6214	mi/h
Distance	km	× 0.6214	mi
	m	× 3.281	ft
	m	× 1.094	yd
	cm	× 0.3937	in
	mm	× 0.03937	in
Volume, Capacity	cc (cm ³)	× 0.03527	oz (IMP liq.)
	cc (cm ³)	× 0.06102	cu-in
	L (liter)	× 0.8799	qt (IMP liq.)
	L (liter)	× 0.2199	gal (IMP liq.)
Miscellaneous	kgf/mm	× 55.997	lb/in
	kgf/cm ²	× 14.2234	psi (lb/in ²)
	°C	× 1.8 + 32	°F

Identification numbers	9-1
Key identification number	9-1
Vehicle identification number	9-1
Model label	9-2
Motorcycle noise regulation (for Australia)	9-2

Identification numbers

Record the key identification number, vehicle identification number and model label information in the spaces provided below for assistance when ordering spare parts from a Yamaha dealer or for reference in case the vehicle is stolen.

EAU02944

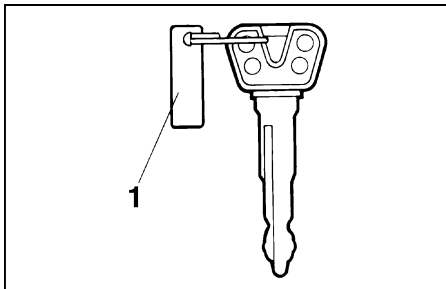

1. Key identification number

1. KEY IDENTIFICATION NUMBER:

2. VEHICLE IDENTIFICATION NUMBER:

3. MODEL LABEL INFORMATION:

EAU01041

Key identification number

The key identification number is stamped into the key tag. Record this number in the space provided and use it for reference when ordering a new key.

EAU01043

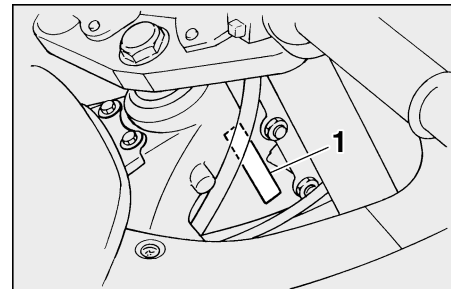

1. Vehicle identification number

Vehicle identification number

The vehicle identification number is stamped into the steering head pipe. Record this number in the space provided.

NOTE: _____

The vehicle identification number is used to identify your motorcycle and may be used to register your motorcycle with the licensing authority in your area.

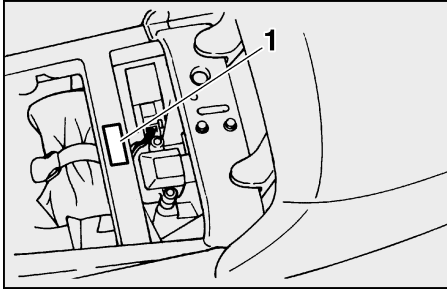

1. Model label

EAU01804

Model label

The model label is affixed to the frame under the rider seat. (See page 3-10 for rider seat removal and installation procedures.) Record the information on this label in the space provided. This information will be needed when ordering spare parts from a Yamaha dealer.

EAU01388

Motorcycle noise regulation (for Australia)

TAMPERING WITH NOISE CONTROL SYSTEM PROHIBITED:

Owners are warned that the law may prohibit:

- (a) The removal or rendering inoperative by any person other than for purposes of maintenance, repair or replacement, of any device or element of design incorporated into any new vehicle for the purpose of noise control prior to its sale or delivery to the ultimate purchaser or while it is in use; and
- (b) The use of the vehicle after such device or element of design has been removed or rendered inoperative by any person.

INDEX

A

Air filter element, cleaning6-15

B

Battery6-29

Brake and clutch fluid levels, checking...6-23

Brake and clutch fluids, changing.....6-24

Brake and clutch levers, checking and lubricating6-25

Brake and shift pedals, checking and lubricating6-25

Brake lever.....3-7

Brake lever free play, adjusting6-21

Brake light switch (rear), adjusting6-22

Brake pads, checking.....6-22

Brake pedal.....3-7

Brake pedal position, adjusting6-21

C

Cables, checking and lubricating.....6-24

Care.....7-1

Catalytic converter.....3-9

Centerstand and sidestand, checking and lubricating6-26

Clutch lever.....3-6

Clutch lever free play6-20

Conversion table8-5

Coolant level, checking6-13

Cowling and panels, removing and installing6-5

D

Dimmer switch.....3-5

Display, multi-function.....3-3

E

Engine break-in5-3

Engine idling speed, checking6-16

Engine oil and oil filter cartridge6-9

Engine stop switch.....3-5

Engine trouble warning light3-2

F

Final gear oil.....6-12

Front and rear suspension settings.....3-15

Front fork, adjusting.....3-11

Front fork, checking6-27

Fuel3-9

Fuel consumption, tips for reducing5-3

Fuel tank cap.....3-8

Fuses, replacing6-30

H

Handlebar switches3-5

Headlight bulb, replacing6-31

High beam indicator light3-2

Horn switch3-5

I

Identification numbers9-1

Ignition circuit cut-off system.....3-17

Indicator and warning lights3-2

K

Key identification number9-1

L

Labels, location1-7

Locks for optional side cases and travel trunk.....3-16

M

Main switch/steering lock3-1

Model label9-2

N

Neutral indicator light3-2

Noise regulation (for Australia)9-2

O

Oil level warning light3-2

P

Parking.....5-4

Part locations2-1

Pass switch.....3-5

Periodic maintenance and lubrication chart6-2

Pre-operation check list.....4-1

S

Safety information1-1

Seats3-9

 Passenger seat.....3-10

 Rider seat3-9

Shifting.....5-2

Shift pedal.....3-6

Shock absorber assembly, adjusting 3-13
Sidestand 3-16
Spark plugs, checking 6-8
Specifications 8-1
Speedometer 3-3
Starting a cold engine 5-1
Start switch 3-5
Steering, checking 6-27
Storage 7-4
Storage compartment 3-10
Suspension (rear), lubricating 6-26

T

Tachometer 3-3
Tail/brake light bulb, replacing 6-32
Throttle cable free play, adjusting 6-17
Throttle grip and cable, checking and
lubricating 6-25
Tires 6-17
Tool kit 6-1
Troubleshooting 6-33
Troubleshooting charts 6-34
Turn signal indicator lights 3-2
Turn signal light bulb, replacing 6-33
Turn signal switch 3-5

V

Valve clearance, adjusting 6-17
Vehicle identification number 9-1

W

Wheel bearings, checking 6-28
Wheels 6-20
Windshield position adjusting switch 3-5



PRINTED ON RECYCLED PAPER

PRINTED IN JAPAN
2001-3-0.3×1 CR
(E)